

Department of the Army  
Pamphlet 385-26

Safety

# The Army Electrical Safety Program

Headquarters  
Department of the Army  
Washington, DC  
1 February 2013

**UNCLASSIFIED**

# ***SUMMARY***

DA PAM 385-26

The Army Electrical Safety Program

This is a new Department of the Army pamphlet, dated 1 February 2013-

- o This pamphlet introduces the Army Electrical Safety Program.

## Safety

### The Army Electrical Safety Program

---

By Order of the Secretary of the Army: (Standard for Electrical Safety in the Workplace®).

RAYMOND T. ODIERNO  
General, United States Army  
Chief of Staff

Official:

  
JOYCE E. MORROW  
Administrative Assistant to the  
Secretary of the Army

---

**History.** This publication is a new Department of the Army pamphlet.

**Summary.** This pamphlet prescribes Army guidelines for protecting Army personnel, facilities, and equipment from electrical hazards. Guidelines were developed from the Consumer Product Safety Commission; Title 29, Code of Federal Regulations Section 1910 Subpart S (Occupational Safety and Health Standards); National Fire Protection Association 70 (National Electric Code®); and National Fire Protection Association 70E

**Applicability.** This pamphlet applies to the Active Army, the Army National Guard/Army National Guard of the United States, and the U.S. Army Reserve, unless otherwise stated. It also applies to Army civilian employees and the U.S. Army Corp of Engineers and Civil Works activities and tenants and volunteers in accordance with Section 1588, Title 10, United States Code and AR 608–1.

**Proponent and exception authority.** The proponent for this pamphlet is the Director of Army Staff. The proponent has the authority to approve exceptions or waivers to this regulation that are consistent with controlling law and regulations. The proponent may delegate this approval authority, in writing, to a division chief within the proponent agency or its direct reporting unit or field operating agency, in the grade of colonel or the civilian equivalent. Activities may request a waiver to this regulation by providing justification that includes a full analysis of the expected benefits and must include formal review by the activity's senior legal officer. All waiver requests will be endorsed by the commander or senior leader of the

requesting activity and forwarded through their higher headquarters to the policy proponent. Refer to AR 25–30 for specific guidance. The proponent has delegated approval authority to Director of Army Safety, Office of the Chief of Staff, Army.

**Suggested improvements.** Users are invited to send comments and suggested improvements on DA Form 2028 (Recommended Changes to Publications and Blank Forms) directly to Director of Army Safety, Office of the Chief of Staff, Army (DACS—SF), 9351 Hall Road, Building 1456, Fort Belvoir, VA 22060–5960.

**Distribution.** This pamphlet is available in electronic media only and is intended for command levels A, B, C, D, and E for the Active Army, the Army National Guard/Army National Guard of the United States, and the U.S. Army Reserve.

---

#### Contents (Listed by paragraph and page number)

##### Chapter 1

##### General Information, page 1

Purpose • 1–1, page 1

Scope • 1–2, page 1

Standard operating procedures • 1–3, page 1

Qualified and unqualified personnel • 1–4, page 1

Training requirements, locations, and records • 1–5, page 1

Electrical near misses and hazard reporting • 1–6, page 1

Authority having jurisdiction • 1–7, page 1

Electrical safety programs evaluation audits and inspections • 1–8, page 1

Risk management • 1–9, page 2

## **Contents—Continued**

### **Chapter 2**

#### **Electrical Safety for All Army Activities, page 2**

General requirements • 2-1, page 2

Precautions for equipment commonly found in workplaces • 2-2, page 2

Adapters • 2-3, page 2

Extension cords • 2-4, page 2

Electrical receptacles • 2-5, page 3

Ground fault circuit interrupters • 2-6, page 5

Portable electric heaters • 2-7, page 5

Power lines • 2-8, page 5

### **Chapter 3**

#### **Electrical Workplace Safety Requirements, page 6**

Introduction • 3-1, page 6

Energized work • 3-2, page 6

Qualified personnel • 3-3, page 6

Electrical hazard analysis • 3-4, page 6

Worksite safety briefing • 3-5, page 6

Control of hazardous energy • 3-6, page 7

Energized electrical work permit • 3-7, page 8

Approach boundaries • 3-8, page 8

Overhead lines • 3-9, page 10

Lineman and similar electrical workers • 3-10, page 12

Warning and alerting techniques • 3-11, page 12

Equipment Safety • 3-12, page 12

### **Chapter 4**

#### **Electrical Workplace Safety Requirements, page 13**

Removal of conductive objects • 4-1, page 13

Required personnel • 4-2, page 13

Working on or near exposed parts • 4-3, page 13

Shock protection • 4-4, page 14

Tasks requiring two hands • 4-5, page 14

Electrical personal protective equipment and protective clothing • 4-6, page 14

Clothing systems • 4-7, page 15

Arc rated clothing • 4-8, page 15

Electric arc hazards • 4-9, page 15

Types of arc rated fabrics • 4-10, page 16

Maintenance and use • 4-11, page 16

Clean and electrical testing of personnel protective equipment • 4-12, page 16

General protective equipment and tools • 4-13, page 16

Emergency and/or rescue equipment • 4-14, page 16

Overcurrent protection • 4-15, page 17

Electrical service failure • 4-16, page 17

### **Chapter 5**

#### **Electrical Safety in Army Facilities, Installations, and Infrastructures, page 17**

Introduction • 5-1, page 17

Grounding • 5-2, page 17

Facility grounding systems • 5-3, page 18

Bonding • 5-4, page 18

Temporary wiring • 5-5, page 18

Electrical panel-boards • 5-6, page 18

Uses of equipment when flammable materials and/or atmospheres are present • 5-7, page 19

Hazardous (classified) locations • 5-8, page 19

## Contents—Continued

Defective or damaged equipment • 5–9, *page 20*

Spaces and/or clearances about electrical and/or electronic equipment • 5–10, *page 20*

Emergency equipment • 5–11, *page 20*

### Chapter 6

**Electrical Safety in Contingency Base Operations**, *page 20*

General • 6–1, *page 20*

Applications of contingency construction standards for electrical installations • 6–2, *page 21*

### Chapter 7

**Tactical Electrical Safety**, *page 21*

Introduction • 7–1, *page 21*

Tactical operations • 7–2, *page 21*

Additional hazards and precautions • 7–3, *page 22*

### Appendixes

**A.** References, *page 23*

**B.** Grounding of Equipment Connected by Cord and Plug, *page 26*

**C.** Ground Fault Circuit Interrupters, *page 28*

**D.** Polarity of Connections, *page 30*

**E.** Grounding, *page 33*

**F.** Grounding Path, *page 35*

**G.** Standards for Electrical Protective Equipment, *page 35*

**H.** Hazard Analysis Factors Prior to Performing Electrical Work, *page 36*

**I.** Guidelines for Equipment Inspection and Approval by the Authority Having Jurisdiction, *page 37*

### Table List

Table 3–1: Limited approach boundary, *page 8*

Table 3–2: Restricted approach distances for qualified personnel, *page 9*

Table 3–3: Limited approach boundary, *page 10*

Table 3–4: Approach distances for qualified employees — alternating current, *page 11*

Table G–1: Standards for electrical protective equipment, *page 35*

Table G–2: Standards for Other Related Protective Equipment, *page 36*

### Figure List

Figure 2–1: Example of a suitable extension cord, *page 3*

Figure 2–2: Hot receptacle outlet (disconnect appliance immediately), *page 4*

Figure 2–3: Incorrect method for unplugging cords, *page 4*

Figure 3–1: Example of tag and lock used for locking out equipment, *page 7*

Figure 4–1: Example of an appropriate personal protective equipment and protective clothing for category 0 or 1 range, *page 15*

Figure 5–1: Example of switch gear, panel boards, and motor control centers, *page 19*

Figure B–1: Cord- and plug-connected equipment without a grounding conductor, *page 27*

Figure B–2: Cord- and plug-connected equipment with a grounding conductor, *page 27*

Figure C–1: Electrical outlet equipped with a ground fault circuit interrupter, *page 28*

Figure C–2: Ground fault circuit interrupters, *page 30*

Figure D–1: Typical 120V branch circuit with correct wiring, *page 31*

Figure D–2: 120V branch circuit with polarity reversed, *page 31*

Figure D–3: Reversed polarity resulting in internal fault in equipment wiring, *page 31*

Figure D–4: White and green wires reversed, *page 32*

Figure D–5: Black and green wires reversed, *page 32*

## **Contents—Continued**

Figure D-6: Duplex receptacle correctly wired to designated terminals, *page 33*

Figure E-1: System and equipment grounding, *page 34*

## **Glossary**

## **Chapter 1**

### **General Information**

#### **1-1. Purpose**

The purpose of this pamphlet is to provide electrical safety guidance to protect Army personnel, facilities, and equipment against electrical hazards. This includes unqualified personnel that use electrical services and appliances in administrative buildings, living in military quarters and/or qualified personnel that conduct electrical work.

#### **1-2. Scope**

This pamphlet applies to all Department of the Army (DA) personnel, including military, civilian, and contractors for safeguarding against the hazards associated with electrical energy. Design of electrical systems, workplace safety, and safety requirements for special electrical equipment will be in compliance with Title 29, Code of Federal Regulations, 1910 Subpart S (29 CFR 1910S); Engineer Manual 385-1-1; Unified Facilities Criteria (UFC) 4-021-01; Technical Bulletin 385-4; UFC 3-560-01; National Fire Protection Association (NFPA) 70 (National Electric Code® (NEC)); and NFPA 70E, as applicable. This pamphlet will highlight procedures and work practices routinely used in Army facilities, workplaces, and recreational and contingency operations. However, local commanders are responsible for establishing electrical safety programs to protect Army personnel, facilities, and equipment in their area of responsibility.

#### **1-3. Standard operating procedures**

Written standard operating procedures (SOPs) are required for those hazardous electrical operations identified through job safety analyses in accordance with Army Regulation (AR) 385-10 (see SOPs). Each initial SOP and any changes or updates will be coordinated and documented with the organization safety office and the appropriate technical advisor.

#### **1-4. Qualified and unqualified personnel**

Only qualified personnel will conduct any electrical related work. Qualified personnel include employees (and their supervisors) working on or near exposed electrical circuits or unlisted equipment posing a shock or arc flash hazard who have received work specific training, and demonstrate knowledge and skills needed to control the hazards associated with the electrical work. A worker may be qualified for one kind of electrical work, but not for another. Unqualified personnel do not perform such work and have not received the required training and are not knowledgeable about the hazards associated with conducting electrical related work.

#### **1-5. Training requirements, locations, and records**

The required training will be classroom or on-the-job, or a combination of the two. Completion of the training, and completion of refresher training, will be documented and maintained on file. Retention of training files for the duration of the personnel's duties involving exposure to electrical and/or electronic work is required.

*a. Qualified person.* Personnel that have been trained, in the classroom or on-the-job or a combination of the two, in: emergency procedures; proper use of special precautionary techniques; proper protective equipment; determining nominal voltage; approach distances; and determining degree and extent of hazard (see NFPA 70E, paragraph 110.6).

*b. Unqualified person.* Personnel that are not qualified electrical workers will be trained in and be familiar with any of the electrical safety related practices that might occur routinely in their work area. All personnel will receive training on general electrical related procedures and hazards and precautions in their workplace.

#### **1-6. Electrical near misses and hazard reporting**

Electrical near misses, to include power surge, repetitive circuit breaker activations (see note below), tripped ground fault circuit interrupter (GFCI), and observed electrical hazards such as downed wires, damaged fixtures, missing guards, and frayed wiring will be reported immediately to the immediate supervisor and the local safety office. These incidents will be investigated to determine cause and will identify, at a minimum, any design or systemic problems or issues, personnel qualifications, equipment malfunctions, and if any procedures were missed or violated. Report this information to the safety office having jurisdiction.

*Note.* Shocks and minor electrical burns are mishaps and must be reported immediately to the supervisor.

#### **1-7. Authority having jurisdiction**

Commanders will appoint an authority having jurisdiction (AHJ) for electrical matters. The AHJ is an organization, office, or individual responsible for approving equipment, materials, an installation, or a procedure. Commanders may use the AHJ appointed by the installation or higher headquarters.

#### **1-8. Electrical safety programs evaluation audits and inspections**

Electrical safety programs will be evaluated as a major element of the Standard Army Safety and Occupational Health

Program in accordance with DA Pamphlet (Pam) 385–10 to ensure that standard procedures are implemented in all elements of electrical safety in accordance with references cited in paragraph 1–2.

### **1–9. Risk management**

An approved risk management worksheet with job hazard analysis is required in all electrical related operations. A risk assessment will be developed in all electrical related operations before work is started within the limited approach boundary or arc flash boundary of energized electrical conductors and circuit parts operating at 50 volts (V) or more or where an electrical hazard exists. Appropriate control measures will be implemented prior to start of work. Job hazard analysis will be developed for all workers working within limited approach boundary or arc flash boundary of energized electrical conductors and circuit parts operating at 50V or more or where an electrical hazard exists.

## **Chapter 2 Electrical Safety for All Army Activities**

### **2–1. General requirements**

The following will apply to all workplaces, including military quarters and field locations:

- a.* Unqualified personnel will not conduct any electrical work and will not approach unprotected energized parts, including power lines. See paragraphs 3–8 through 3–10 for specific distances.
- b.* All electrical equipment used in Army workplaces will be listed by a NRTL or inspected and approved by the AHJ.
- c.* Military equipment released to the field under the auspices of AR 700–142 will be considered as equivalent to NRTL-listed equipment.
- d.* All equipment will be used in accordance with the listing.
- e.* All equipment will be used in accordance with manufacturer’s instructions or technical manuals.
- f.* Maintenance will be performed on electrical equipment in accordance with manufacturer’s instructions and technical manual instructions.

### **2–2. Precautions for equipment commonly found in workplaces**

The equipment in paragraphs 2–3 through 2–8 is found in many workplaces. Specific precautions and instructions for these will be applied.

### **2–3. Adapters**

Adapters to plug three-prong electrical plugs into two-prong receptacles are prohibited. These defeat the electrical grounding circuit and can create a hazard. See appendix B for additional guidance on grounding.

### **2–4. Extension cords**

Use extension cords only when necessary and only on a temporary basis. The following usage guidelines apply:

- a.* Use only polarized extension cords with polarized appliances (see fig 2–1).
- b.* Make sure cords do not dangle from the counter or table tops where they can be pulled down or tripped over.
- c.* Replace cracked or worn extension cords with appropriately rated and sized cords that have NRTL listing, safety closures, and other safety features (see fig 2–1).
- d.* Insert plugs fully so that no part of the prongs is exposed when the extension cord is in use.
- e.* When disconnecting cords, pull the plug rather than the cord itself. Pulling on the cord damages the conductors and the terminations in the plug.
- f.* Check the plug and the body of the extension cord while the cord is in use. Replace the cord if it is hot. This is an indication that the cord is overloaded and should be replaced with a cord having larger conductors.
- g.* Never use a coiled or looped extension cord. Never cover any part of an extension cord with newspapers, clothing, rugs, or any objects because it can overheat and cause a fire. Protect the cord when it is being used in an area where it is likely to be damaged by heavy furniture or foot traffic.
- h.* Do not use staples or nails to attach extension cords to a baseboard or to another surface. This could damage the cord and present a shock or fire hazard.
- i.* Ensure appliances are used with cords that are rated at or above the current and voltage need by the appliance.
- j.* Use only three-wire extension cords for appliances and power tools with three-prong plugs. Never remove the third (round or U-shaped) grounding prong, which is a safety feature designed to reduce the risk of shock and electrocution. Never use adaptors designed to defeat the grounding connection. Flexible cord used with grounding type equipment will contain an equipment grounding conductor.



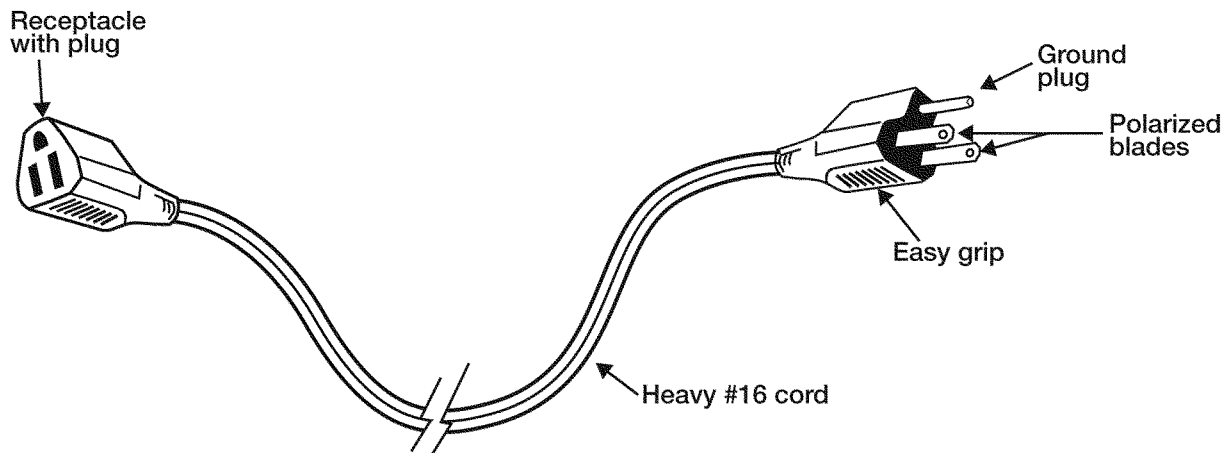

Figure 2-1. Example of a suitable extension cord

- k. Check new cords to make sure they are listed by a NRTL.
- l. When using outdoor tools and appliances, use only extension cords labeled for outdoor use and protected by a GFCI device.
- m. Never repair electrical cords.
- n. Stringing of extension cords (daisy chain or splitting) or going from one cord to several (tree branching) is prohibited unless approved by local safety authority.
- o. Use power strips only for low amperage equipment such as computer monitor, fan, computer, printer, and so forth and they will not be daisy chained. Do not plug extension cords into plug strips.
- p. Only authorized and qualified electricians may repair cords. Repaired cords are no longer covered by NRTLs (such as UL, FM, TUV). Therefore, a risk assessment must be considered prior to reusing repaired cords. All repairs will meet the requirements of NFPA 70 (NEC), Sections 110.14(B) and 400.9.
- q. Do not run extension cords through windows, holes in walls, in between doors, or under carpets or rugs.
- r. Do not use extension cords with electrical appliances when the manufacturer's instructions warn against their use.
- s. Do not use extension cords in areas where flammable liquids are stored or used unless they are properly rated in accordance with NFPA 70 (NEC).
- t. Hands must not be wet when plugging and unplugging flexible cords and connected equipment.
- u. Handle portable equipment and flexible cords in a manner which will not place the handler and/or user at risk or cause damage.
- v. Do not use extension cords to raise and lower equipment.
- w. Cord- and plug-connected tools and equipment have the same issues as extension cords; therefore, these requirements also apply to their use.
- x. Portable cord- and plug-connected equipment and flexible cord sets (extension cords) will be visually inspected for external defects (such as loose parts, deformed and missing pins, or damage to outer jacket or insulation) before use on any shift, and for evidence of possible internal damage (such as pinched or crushed outer jacket). Cord- and plug-connected equipment and flexible cord sets (extension cords) which remain connected once they are put in place and are not exposed to damage need not be visually inspected until they are relocated. If there is a defect or evidence of damage that might expose an employee to injury, the defective or damaged item will be removed from service, and no employee may use it until repairs and tests necessary to render the equipment safe have been made by a qualified electrician.
- y. When using extension cords and cord- and plug-connected equipment in wet or damp locations, indoor or outdoor, a GFCI will be used for protection against shock or electrocution.
- z. Job-made extension cords are prohibited. Only purchased, approved extensions cords are acceptable.

## 2-5. Electrical receptacles

Electrical outlets in walls and floors may present shock and electrical fire hazards to Army personnel, facilities, and equipment. Use and install receptacles in accordance with NFPA 70 (NEC) and manufacturer's instructions. The following are general guidelines:

a. Only qualified personnel will install receptacles or replace damaged receptacles or those which feel hot, emit smoke or sparks, have loose fitting plugs, have signs of melting or carbonization (soot), or those where plugged-in lamps flicker or fail to light.

b. Receptacles installed on 15- and 20-ampere branch circuits will be of the grounding-type. Grounding-type receptacles will be installed only on circuits of the voltage class and current for which they are rated.

c. Receptacles will be mounted in boxes or assemblies designed for the purpose and such boxes or assemblies will be securely fastened in place.

d. Receptacle faceplates will be installed so that they completely cover the opening and seat against the mounting surface. Replace damaged faceplates.

e. Damaged and deteriorated receptacles must be replaced immediately after identification and marked and/or labeled to prevent use until replaced.

f. To prevent damage to receptacles, appliances should be switched off before unplugging from a receptacle.

g. GFCI-protected receptacles will be installed in all potentially wet locations (for example, restrooms, outdoors, pools, spas, garages, sinks of any type, and so forth) and indoor outlets that serve these locations (see NFPA 70 (NEC), Section 210.8).

h. Properly identify and label all GFCI receptacles.

i. Immediately discontinue use of a receptacle outlet that is too hot (see fig 2-2). Obtain help from a qualified electrician as soon as possible. Follow local procedures for contacting a qualified electrician. Contact your supervisor.

j. Do not unplug appliances by pulling on the cord (see fig 2-3). The brittle plastic face of the receptacle may crack and break away, leaving live parts of the receptacle exposed. Unplugging by pulling on the cord also damages the cord by breaking strands of the conductors.

k. Attachment plugs and receptacles must not be connected or altered in a manner which would prevent proper continuity of the equipment grounding conductor at the point where plugs are attached to receptacles. Attachment plugs and receptacles must not be altered to allow the grounding pole of a plug to be inserted into slots intended for connection to the current-carrying conductors. Adapter plugs that defeat the grounding connections will not be used.

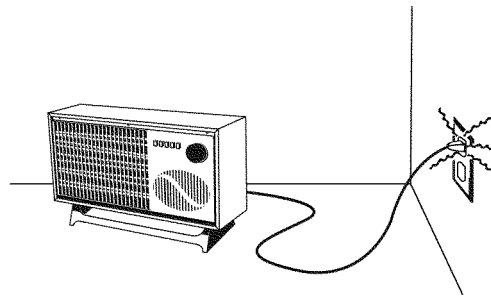

Figure 2-2. Hot receptacle outlet (disconnect appliance immediately)

---

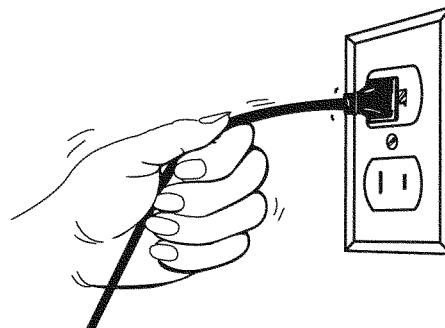

Figure 2-3. Incorrect method for unplugging cords

---

## 2-6. Ground fault circuit interrupters

a. GFCIs will be used where power outlets are required in damp or wet locations and within 6 feet (ft) (1.83 meters (m)) of a water source. GFCIs are required for power outlets where live maintenance work is performed on cord- and plug-connected equipment (see app C for details on GFCIs).

(1) Verification of correct installation of GFCIs is required. Officials in charge of maintenance facilities should verify that the following initial test has been or is performed on each GFCI-protected circuit:

(a) First, plug known working electrical equipment, such as a lamp or a radio, into the GFCI outlet, turn it on, and verify that it operates (receives power).

(b) Then, press the Push-to-Test button on the receptacle. Verify that the equipment turns off and remains off, indicating that power has been removed.

(c) Finally, press the Reset button on the GFCI. Verify that the equipment operates.

(2) If pressing the Push-to-Test button does not interrupt power to the equipment, ask the installation or facility electrician to check to see if the GFCI is correctly wired. In addition to this initial test, the Push-to Test button will be tested monthly.

b. Periodic testing with a GFCI tester is recommended to ensure the GFCI is functioning at the correct current levels. Replace defective GFCI receptacles.

c. All cord- and plug-connected electrical equipment and power tools, as well as extension cords and plug strips, will be protected by a GFCI. A portable GFCI will be used when a permanently installed GFCI receptacle is not available.

## 2-7. Portable electric heaters

The local command will establish a policy on portable electric heaters. Portable electric heaters are high-wattage appliances that have the potential to overload circuits and/or cords or ignite nearby combustible materials like curtains, beds, sofas, paper, clothing, and flammable liquids. If ignition results from a heater left on and unattended, a major fire could result.

a. Never operate a heater suspected of being damaged. Before use, inspect the heater, cord, and plug for damage. Follow all operation and maintenance instructions or visit <http://www.recalls.gov> to see if that model of electric heater has been recalled. Also visit the Consumer Safety Product Services Web site at <http://www.cpsc.gov> for additional information.

b. Never leave the heater operating while unattended or while sleeping.

c. Keep combustible material such as beds, sofas, curtains, papers, and clothes at least 3 ft (0.9 m) from the front, sides, and rear of the heater.

d. Be sure the heater plug fits tightly into the wall outlet. If not, do not use the outlet to power the heater.

e. During use, check frequently to determine if the heater plug or cord, wall outlet, or faceplate is hot. If so, discontinue use of the heater and have a qualified electrician check and/or replace the plug or faulty wall outlet(s). If the cord is hot, disconnect the heater, and have it inspected and/or repaired by an authorized repair person.

f. Never power the heater with an extension cord or power strip.

g. Ensure that the heater is placed on a stable, level surface, and located where it will not be knocked over.

h. Always keep electric heaters away from water, and never touch an electric heater if skin or clothing is wet.

i. In older buildings, consult with supporting facility electricians to determine if the building wiring can support the additional load of portable electric heaters.

## 2-8. Power lines

a. *Downed electrical wires.*

*Note.* Everything is assumed to be energized until tested and confirmed to be de-energized.

Fallen power lines (even if they are not sparking or humming) can kill if touched, or even the ground nearby is touched. Downed wires can energize other objects, including fences, water pipes, bushes and trees, buildings, telephone/cable television/fiber optic cables, man-hole castings, reinforcement bars in pavement, and other electric utilities. During storms, downed wires can also energize wind-blown objects such as canopies, aluminum roofs, siding, sheds, and so forth. Be cautious and contact appropriate utility personnel if downed wires or damaged electrical equipment are observed. Circuits do not always turn off when a power line falls into a tree or onto the ground.

(1) Do not assume that a downed conductor is safe simply because it is on the ground or is not sparking.

(2) Do not assume that all coated, weatherproof, or insulated wire is just telephone, television, or fiber-optic cable. Test it to ensure it is not live before touching it.

(3) Low-hanging wires still have voltage potential even if they are not touching the ground. Do not touch them.

(4) Never drive over downed power lines. Assume that they are energized. If they are not energized, downed lines

can still become entangled in equipment or vehicles and cause damage or injury. If contact is made with an energized power line while in a vehicle, remain calm and do not get out unless the vehicle is on fire. If possible, call for help.

(5) If exiting a vehicle is required because of fire or other life-threatening hazards, jump clear of the vehicle without touching any part of it and the ground at the same time. Jump as far as possible away from the vehicle, shuffle away with both feet on the ground, or hop away, with both feet landing on the ground at the same time. Do not run away from the vehicle as the electricity forms rings of different voltages. Running may cause legs to “bridge” current from a higher ring to a lower voltage ring. This could result in a shock. Get a safe distance away.

*b. Overhead power lines.*

(1) Items caught in or contacting overhead lines may be energized and dangerous. Do not attempt to remove. Report to the utility service.

(2) Use extreme caution when working, placing, and/or moving items (for example, ladders, poles, tree trimming equipment, and so forth) near power lines (see para 3–8 for specific distance requirements).

## **Chapter 3 Electrical Workplace Safety Requirements**

### **3–1. Introduction**

This section focuses on protection of unqualified and qualified personnel working in workplaces where electrical work is conducted. This electrical work includes work performed on the facility distribution system, on electrical utilization equipment, or on overhead lines.

### **3–2. Energized work**

Where ever possible, de-energize electrical circuits and equipment. Energized work will not be conducted unless it is determined that de-energization is not possible. An Energized Electrical Work Permit (EEWP) must be completed and de-energized work must be authorized by the AHJ prior to commencement. The EEWP will be designed by local command as an element of the Command Electrical Safety Program, to include local EEWP procedures.

### **3–3. Qualified personnel**

Only qualified personnel will conduct electrical work and will be permitted to determine the energization state of circuits before work is performed.

### **3–4. Electrical hazard analysis**

An electrical hazard analysis will be conducted by qualified supervisors of all Army operations where electrical work is conducted on facility electrical distribution systems or electrical equipment or devices within the limited approach boundary of exposed, energized electrical conductors or circuit parts, and/or working within the arc flash boundary of electrical equipment, in accordance with NFPA 70E. This analysis consists of a shock hazard analysis and an arc flash hazard analysis. The shock hazard analysis will be used to determine the voltage of the circuits and equipment, establish the shock hazard boundaries (limited, restricted, prohibited), and the required protective equipment for protection against electrical shock. The arc flash hazard analysis will determine the arc flash energy (measured in calories/square centimeters (cal/cm<sup>2</sup>)); establish the arc flash boundary (established at 1.2 cal/cm<sup>2</sup>, which is the onset of a second-degree burn); and determine the appropriate arc rated clothing and PPE against arc flash hazards. Additional details on conducting the shock hazard analysis and arc flash hazard analysis are contained in NFPA 70E, Chapter 1, Articles 130.4 and 130.5. Use Annex D in NFPA 70E to establish the arc flash protection boundary.

### **3–5. Worksite safety briefing**

Whenever work involves accessing energized parts, the qualified person in charge will conduct a job safety briefing with the personnel performing the work.

*a.* The job safety briefing will address, at a minimum—

- (1) Hazards associated with the work.
- (2) Procedures involved in the work.
- (3) Any special precautions required to maintain electrical safety.
- (4) Control of energy sources.
- (5) PPE and clothing required for the work.
- (6) Location of emergency and/or first aid equipment.
- (7) Emergency call number and procedures.
- (8) Voltage of circuits and equipment.
- (9) Shock hazard boundaries.
- (10) Arc flash energy.

(11) Arc flash protection boundary.

(12) Location and procedure for emergency power disconnect.

b. For routine work, a brief discussion will meet the requirement if the employee, due to training and experience, can reasonably be expected to recognize and avoid the hazards involved in the job. Additional job briefings will occur if any one of the following conditions exists:

(1) New and unfamiliar work.

(2) Performed infrequently.

(3) Outside of normal duties.

(4) Performed differently than in a documented procedure.

(5) Complicated work or incurs new electrical hazards.

(6) Worker cannot be expected to recognize and avoid the hazards involved in the job (in particular, this may apply to newly assigned personnel).

### 3-6. Control of hazardous energy

a. *Lockout and/or tagout.* Each employer will document and implement lockout and/or tagout procedures to safeguard employees from injury while they are working on or near de-energized electric circuits and equipment. The lockout and/or tagout procedures will meet the requirements of DA Pam 385-10 (see lockout and/or tagout); NFPA 70E, Chapter 1, Article 120; and 29 CFR 1910.147(c) through (f), 1910.269(d) through (m), 1910.333; and 29 CFR 1926.417 (see fig 3-1).

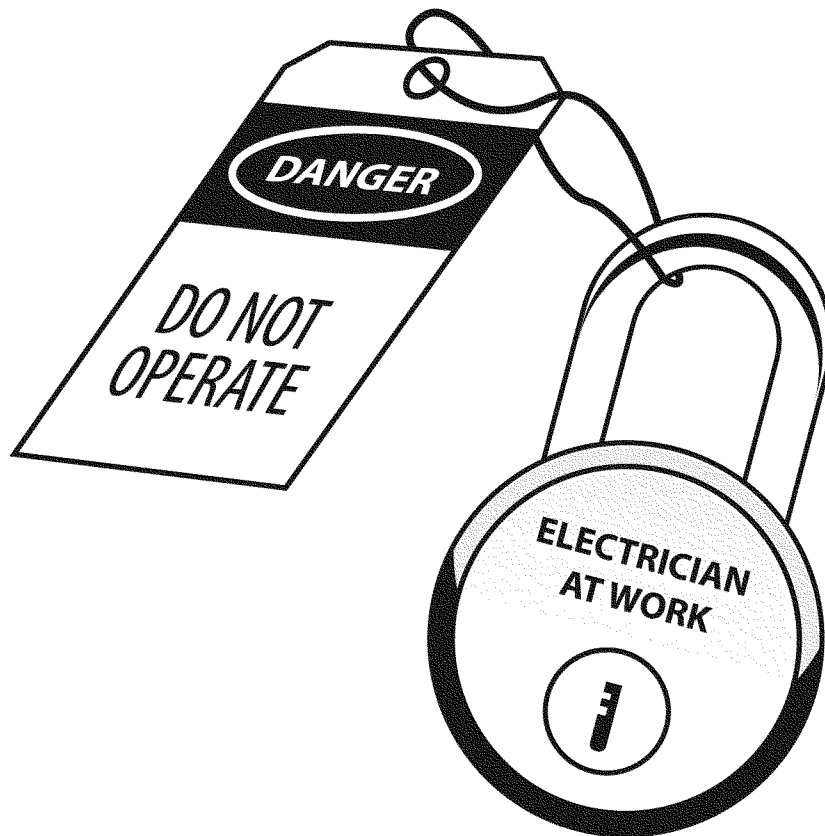

LF930015

Figure 3-1. Example of tag and lock used for locking out equipment

*b. De-energization.* The first choice in performing electrical work is to remove the electrical hazard, or de-energize equipment. De-energization will be the preferred method of establishing electrical safety and working on electrical equipment. De-energization procedures will include—

- (1) Determining all possible sources of electrical energy.
- (2) Opening disconnecting devices and/or disconnecting power sources and verifying they are (electrically) open. Equipment will be disconnected from power sources where possible.
- (3) Preventing accidental and/or inadvertent reconnection of the equipment. For most equipment, removing the supply cable and keeping it in view (within 6 ft (1.83 m)) and under direct control during maintenance is adequate. For larger equipment or permanently installed equipment, lockout and/or tagout may be necessary to test to verify de-energization.

*Note.* Ensure test equipment is functioning properly by using a known voltage source before relying upon it for de-energization testing and verify the test equipment is still functioning correctly by using the known source again after the de-energization test.

- (4) Grounding circuit parts before contact. There may be the possibility that stored or induced electrical energy exists (for example, capacitors).

### 3-7. Energized electrical work permit

When electrical work is going to be conducted within the limited approach boundary or arc flash boundary of energized electrical conductors or circuit parts operating at 50V or more, or where an electrical hazard exists, an EEWP will be required. In accordance with NFPA 70E, Section 130.1, a written permit is required when working on energized electrical conductors or circuit parts that are not placed in an electrically safe work condition. The AHJ will approve the written EEWP, under risk authority established by the commander.

### 3-8. Approach boundaries

Approach boundaries specify minimum safe distances from exposed energized electrical circuits or circuit parts posing a shock hazard (limited, restricted, and prohibited approach) or an arc flash hazard (arc flash boundary).

*a. Limited approach boundary.* The boundary is to protect unqualified personnel (not performing work on exposed energized electrical circuits above 50V and untrained in such work) from a shock hazard.

- (1) Unqualified personnel may not approach energized exposed electrical parts or bring conductive objects within 10 ft (3 m) or the distance as dictated by following table 3-1. If approach within these distances is required, a qualified person will be notified to de-energize the parts or appropriate PPE or temporary insulating barriers will be utilized.
- (2) Warning signs or temporary barriers will be installed in areas where energized electrical parts are exposed. Unqualified persons will be escorted by a qualified person within this area. In maintenance shops, where exposed energized parts are commonly encountered, permanent signs affixed to all entrances to the shop area will meet the signage requirement. Warning signs will be orange and black with a warning for areas that have exposed voltages from 50 to 600V, in accordance with the American National Standards Institute (ANSI) Z535.4. Areas that have exposed voltages exceeding 600V will be posted with red, white, and black DANGER signs. The sign will read “Danger-High Voltage-Keep Out” per NFPA 70 (NEC), Section 110.34(C) and 29 CFR 1910.303(h)(5)(iii). New signs should meet ANSI Z535.2-2011 standard. For system voltages with exposed moveable conductors with fixed circuit parts use distances specified in table 3-1.

**Table 3-1**  
**Limited approach boundary<sup>1</sup>**

Voltage range (phase to phase) <sup>2</sup>	Exposed movable conductor <sup>3</sup> (Minimum approach distance)	Exposed fixed circuit part (Minimum approach distance)
750V and less	10 ft 0 in <sup>4</sup> (3.05 m)	3 ft 6 in (1.07 m)
Over 750V, not over 15kV <sup>3</sup>	10 ft 0 in (3.05 m)	5 ft 0 in (1.53 m)
Over 15kV, not over 36kV	10 ft 0 in (3.05 m)	6 ft 0 in (1.83 m)
Over 36kV, not over 72.5kV	10 ft 0 in (3.05 m)	8 ft 0 in (2.44 m)
Over 72.5kV, not over 121kV	10 ft 8 in.(3.25 m)	8 ft 0 in (2.44 m)
Over 121kV, not over 145kV	11 ft 8 in (3.36 m)	10 ft 0 in (3.05 m)
Over 145kV, not over 169kV	11 ft 8 in (3.56 m)	11 ft 8 in (3.56 m)
Over 169kV, not over 242kV	13 ft 0 in (3.97 m)	13 ft 0 in (3.97 m)
Over 242kV, not over 362kV	15 ft 4 in (4.68 m)	15 ft 4 in (4.68 m)
Over 362kV, not over 550kV	19 ft 9 in (5.8 m)	19 ft 0 in (5.8 m)

**Table 3-1**  
**Limited approach boundary<sup>1</sup>—Continued**

Over 550kV, not over 800kV	23 ft 9 in (7.24 m)	23 ft 9 in (7.24 m)
----------------------------	---------------------	---------------------

Notes:

<sup>1</sup> Table taken from NFPA 70E, 2012 Edition.

<sup>2</sup> For single-phase systems, select the range that is equal to the system's maximum phase-to-ground voltage multiplied by 1.732.

<sup>3</sup> A condition in which the distance between the conductor and a person is not under the control of the person. The term is normally applied to overhead line conductors supported by poles.

<sup>4</sup> The following abbreviations are introduced in this chart: kV (kilovolt) and in (inch).

*b. Restricted approach boundary.* The boundary is to protect qualified personnel working near exposed electrical circuits above 50V from inadvertent contact with those circuits.

(1) Only qualified personnel may access live electrical parts or approach electrical parts within the restricted approach distances specified in table 3-2.

**Table 3-2**  
**Restricted approach distances for qualified personnel<sup>1</sup>**

Voltage range (phase to phase)	Minimum approach distance <sup>2</sup>
300V and less	Avoid contact
Over 300V, not over 750V	1 ft 0 in (304.8 mm) <sup>3</sup>
Over 750V, not over 15kV	2 ft 2 in (660.4 mm)
Over 15kV, not over 36kV	2 ft 7 in (787.4 mm)
Over 36kV, not over 46kV	2 ft 9 in (838.2 mm)
Over 46kV, not over 121kV	3 ft 4 in (1.016 m)
Over 121kV, not over 145kV	3 ft 10 in (1.168 m)
Over 145kV, not over 169kV	4 ft 3 in (1.295 m)
Over 169kV, not over 242kV	5 ft 8 in (1.727 m)
Over 242kV, not over 362kV	9 ft 2 in (2.794 m)
Over 362kV, not over 550kV	11 ft 10 in (3.607 m)
Over 550kV, not over 800kV	15 ft 11 in (4.852 m)

Notes:

<sup>1</sup> Table taken from NFPA 70E, 2012 Edition.

<sup>2</sup> For the purpose of this table, no qualified person will approach or take any conductive object, tool, and so forth, within the minimum approach distance. Where electrical measurements of energized equipment is required, insulating components of test equipment will be construed as meeting the "avoid contact."

<sup>3</sup> The following abbreviation is introduced in this chart: mm (millimeter).

(2) The minimum approach requirement for under 300V is in table 3-2, provided the test equipment is rated for that voltage. Requirements for PPE and voltage rated gloves are determined by an arc flash and shock hazard analysis, and may be required.

*c. Prohibited approach boundary.* The boundary is to protect working qualified personnel from contacting an uninsulated body part to an energized electrical circuit (see table 3-3).

(1) Hazard and/or risk analysis must be performed to determine insulated protective equipment (rubber insulating gloves with leather protectors, rubber insulating blankets, and so forth) and insulated and/or insulating hand tools required within this boundary.

(2) NFPA 70E defines protective equipment based on the electrical equipment being worked on and the type of work performed. For work meeting those definitions, PPE specified in NFPA 70E can be used provided written documentation (for example, local SOPs, regulations, guidelines, and so forth) references the appropriate table and definition that defines work being performed.

**Table 3–3  
Limited approach boundary<sup>1</sup>**

Voltage range (phase to phase) prohibited distance	Prohibited distance (at or less than stated distance)
300V and less	Avoid contact
Over 300V, not over 750V	0 ft 1 in (25.4 mm)
Over 750V, not over 15kV	0 ft 7 in (177.8 mm)
Over 15kV, not over 36kV	0 ft 10 in (254 mm)
Over 36kV, not over 46kV	1 ft 5 in (431.8 mm)
Over 46kV, not over 72.5kV	2 ft 2 in (661 mm)
Over 72.5kV, not over 121kV	2 ft 9 in (838 mm)
Over 121kV, not over 145kV	3 ft 4 in (1.016 m)
Over 145kV, not over 169kV	3 ft 9 in (1.143 m)
Over 169kV, not over 242kV	5 ft 2 in (1.575 m)
Over 242kV, not over 362kV	8 ft 8 in (2.642 m)
Over 362kV, not over 550kV	11 ft 4 in (3.454 m)
Over 550kV, not over 800kV	15 ft 5 in (4.699 m)

Notes:

<sup>1</sup> Table taken from NFPA 70E, 2012 Edition.

<sup>2</sup> The following abbreviation is introduced in this chart: cm (centimeter).

*d. Arc flash boundaries.* Arc flash hazards are possible on electrical systems and equipment rated 208V, three-phase, or more, if work is conducted on energized electrical conductors or circuit parts, while a person is interacting with the electrical equipment (opening or closing circuit breakers and disconnect switches or racking power circuit breakers out of or into a cubicle), and during the process of establishing an electrically safe work condition (lockout/tagout). An arc flash can occur when electrical parts are shorted, or may occur when the electrical equipment fails due to improper or inadequate maintenance, where the resulting arc produces an intense flash of ultraviolet light, a radiant energy (incident energy), a shock wave from the arc, and a spray of molten metal from the superheated metal parts. In general, arc flash hazards are prevalent on power circuits and equipment energized at 208V, three-phase or more. An arc flash boundary can exceed the shock hazard approach distances for qualified personnel and, in some cases, unqualified workers. Where an arc flash hazard analysis has not yet been completed, the requirements of UFC 3–560–01, Chapter 4, will be used to determine the proper arc flash PPE. An arc flash hazard analysis will be conducted in accordance with the requirements of NFPA 70E. Contact the installation and/or organization safety office for technical assistance, if needed.

(1) *Maintenance.* Maintenance of electrical protective devices (circuit breakers, protective relays, and so forth), according to the manufacturer’s instructions, is required in order to maintain safe, reliable electrical equipment and systems. Improper maintenance can have a dramatic impact on arc flash energy (see NFPA 70E, Sections 130.5 and 205.3) This generally is not the case for maintenance and testing of electronic equipment, even those having higher voltages, because the possible current is limited.

(2) *Operating conditions.* Under normal operating conditions, enclosed energized electrical conductors or circuit parts of equipment that are properly installed and maintained are less likely to pose an arc flash hazard. On the other hand, exposed electrical conductors and circuit parts that are either improperly maintained or operated pose a potential arc flash hazard.

### 3–9. Overhead lines

If work is to be performed near overhead lines, the lines will be de-energized and grounded, or other protective measures will be provided before work is started. If the lines are to be de-energized, arrangements will be made with the person or organization that operates or controls the electric circuits involved to de-energize and ground them. If protective measures, such as guarding, isolating, or insulating are provided, these precautions will prevent employees from contacting such lines directly with any part of their body or indirectly through conductive materials, tools, or equipment.

#### *a. Unqualified persons.*

(1) When an unqualified person is working in an elevated position near overhead lines, the location will be such that the person and the longest conductive object he or she may be handling cannot come closer to any unguarded, energized overhead line than the following distances:

(a) For voltages to ground 50kV or below - 10 ft (305 cm).



(b) For voltages to ground over 50kV - 10 ft (305 cm) plus 4 in (10 cm) for every 10kV over 50kV.

(2) When an unqualified person is working on the ground in the vicinity of overhead lines, the person may not bring any conductive object closer to unguarded, energized overhead lines than the distances given in subparagraphs (1)(a) and (b), above.

*Note.* For voltages normally encountered with overhead power lines, objects which do not have an insulating rating for the voltage involved are considered to be conductive.

*b. Qualified persons.* When a qualified person is working in the vicinity of overhead lines, whether in an elevated position or on the ground, the person may not approach or take any conductive object without an approved insulating handle closer to exposed energized parts than shown in table 3-4 unless—

(1) The person is insulated from the energized part (gloves, with sleeves if necessary, rated for the voltage involved are considered to be insulation of the person from the energized part on which work is performed); or

(2) The energized part is insulated both from all other conductive objects at a different potential and from the person; or

(3) The person is insulated from all conductive objects at a potential different from that of the energized part.

**Table 3-4**  
**Approach distances for qualified employees — alternating current<sup>1</sup>**

Voltage range (phase to phase)	Minimum approach distance
300V and less	Avoid contact
Over 300V, not over 750V	1 ft 0 in (30.5 cm)
Over 750V, not over 2kV	1 ft 6 in (46 cm)
Over 2kV, not over 15kV	2 ft 0 in (61 cm)
Over 15kV, not over 37kV	3 ft 0 in (91 cm)
Over 37kV, not over 87.5kV	3 ft 6 in (107 cm)
Over 87.5kV, not over 121kV	4 ft 0 in (122 cm)
Over 121kV, not over 140kV	4 ft 6 in (137 cm)

Notes:

<sup>1</sup> Table taken from NFPA 70E, 2012 Edition.

*c. Vehicular and mechanical equipment.*

(1) Any vehicle or mechanical equipment (cranes, man lifts, uninsulated bucket trucks, backhoes, dump trucks, and so forth) capable of having parts of its structure elevated near energized overhead lines will be operated so that a clearance of 10 ft (305 cm) is maintained. If the voltage is higher than 50kV, the clearance will be increased 4 in (10 cm) for every 10kV over that voltage. However, under any of the following conditions, the clearance may be reduced:

(a) If the vehicle is in transit with its structure lowered, the clearance may be reduced to 4 ft (122 cm). If the voltage is higher than 50kV, the clearance will be increased 4 in (10 cm) for every 10kV over that voltage.

(b) If insulating barriers are installed to prevent contact with the lines, and if the barriers are rated for the voltage of the line being guarded and are not a part of or an attachment to the vehicle or its raised structure, the clearance may be reduced to a distance within the designed working dimensions of the insulating barrier.

(c) If the equipment is an aerial lift insulated for the voltage involved, and if a qualified person performs the work, the clearance (between the uninsulated portion of the aerial lift and the power line) may be reduced to the distance given in table 3-4.

(2) Employees standing on the ground may not contact the vehicle or mechanical equipment or any of its attachments unless—

(a) The employee is using protective equipment rated for the voltage; or

(b) The equipment is located so that no uninsulated part of its structure (that portion of the structure that provides a conductive path to employees on the ground) can come closer to the line than permitted in subparagraphs (1)(a) and (b), above.

(3) If any vehicle or mechanical equipment capable of having parts of its structure elevated near energized overhead lines is intentionally grounded, employees working on the ground near the point of grounding may not stand at the grounding location whenever there is a possibility of overhead line contact. Additional precautions, such as the use of barricades or insulation, will be taken to protect employees from hazardous ground potentials, depending on earth resistivity and fault currents, which can develop within the first few ft or more outward from the grounding point.

Employees will wear appropriate PPE and protective clothing to protect them from hazards of high-voltage apparatus. Employees authorized or required to work on high-voltage systems will be completely familiar with the PPE and protective clothing they need for adequate protection while working on such systems (refer to applicable standards in app G for suggested types of PPE and protective clothing).

*d. Tactical equipment.*

(1) Tactical equipment may have additional precautions. Check technical manuals before use.

(2) Tactical antenna masts usually require clearance of twice the height of the mast for clearance from power lines and other energized parts.

### **3-10. Lineman and similar electrical workers**

Overhead wire linemen, underground high voltage mechanics, exterior high voltage test and evaluation personnel, and all contractors engaged in similar work on Army-owned or controlled settings have the potential to come in contact with energized conductors. This includes those individuals that maintain traffic signals, outside (pole) lights, signs, and any other operation involving hazardous energy in elevated or underground applications. Individuals that only work on communications, supervisory control and data acquisition industrial control systems, cable television, and similar low-voltage systems may be partially or completely exempted from these requirements by the local command.

*a.* All linemen are required to comply with the requirements of 29 CFR 1910, UFC 3-560-01, NFPA 70 and any standards adopted by the utility supplying the Army facility, as needed. In the event that a utility regulation conflicts with this requirement, the AHJ will determine the requirement. There will always be a minimum of two qualified linemen working at the same location.

*b.* Linemen must also be able to demonstrate competency when working at elevated or underground conditions. Qualifications will include fall arrest training, harness selection and use, confined space rescue training, and pole rescue training. Commands are permitted to require additional training such as tower line safety, high voltage maintenance safety, and so forth.

*c.* Linemen will meet appropriate physical and medical suitability requirements as determined by the local command and the AHJ.

*d.* Linemen will be provided with PPE appropriate to their tasks as determined by the local command and AHJ.

*e.* Electrical workers and/or linemen will be trained for confined space entry, as appropriate.

### **3-11. Warning and alerting techniques**

The following warning and alerting techniques will be used to warn and protect employees from hazards which could cause injury due to electric shock, burns, or failure of electric equipment parts:

*a.* Safety signs, safety symbols, or accident prevention tags will be used to warn employees about electrical hazards which may endanger them. Appropriate warning signs will also be posted in areas where other hazards are known to exist. Warning signs may be required in the vicinity of toxic fumes, high-intensity visible light, X-ray producing equipment, laser devices, radio frequency equipment, and radioactive materials.

*b.* Barricades will be used in conjunction with safety signs to prevent or limit employee access to work areas exposing employees to uninsulated, energized conductors, or circuit parts. Conductive barricades may not be used where they might cause an electrical contact hazard.

*c.* If signs and barricades do not provide sufficient warning and protection from electrical hazards, an attendant will be stationed to warn and protect employees.

### **3-12. Equipment Safety**

Faulty electrical equipment or equipment misuse has been the cause of many fires, injuries, and deaths. In fact, electrical fires are the number one cause of fire in the workplace.

*a.* When using electrical equipment, a worker is protected primarily by engineering controls (design features) that prevent the worker from being exposed to the hazard. The worker needs no special work controls or protective equipment.

*b.* When engineering controls are absent, or removed, the worker must be protected by administrative controls, including training, work control such as a SOP, and PPE. There are many levels between these two extremes. Regardless, all workers are responsible for using safe equipment and reporting damage, degradation, or modification that might affect engineering controls.

*c.* All electrical equipment that contains or produces energy greater than 50V alternating current (AC) or 100V direct current (DC) must meet one of the following conditions to be safe for use:

(1) Listed by a NRTL and used as intended (for example, as described in the manufacturer's instructions or technical manual). NRTLs examine equipment, and those that have engineering controls that make them safe for the user are stamped with a listing symbol. NRTLs approved by the Occupational Safety and Health Administration are listed at <http://www.osha.gov/dts/otpca/nrtl/nrtllist.html>.

*Note.* The NRTL mark is often found near the power cord where it enters the equipment. If equipment plugs into the wall (either at

home of in the office), it should have one of these marks. If not, do not use the equipment. All potential equipment users (Family and friends) should be taught to look for NRTL marks.

(2) It is military unique equipment released to the field under the auspices of AR 700–142 and is used as intended; this equipment is considered equivalent to NRTL-listed equipment.

(3) It is manufactured by a reputable manufacturer as defined by the AHJ and is used as intended.

(4) It is inspected, approved, and labeled as safe for its intended use by the AHJ. Inspection requirements are detailed in appendix I.

*d.* Equipment sold in the European Union (EU) bears a CE (European Conformity) marking. CE is not accepted by the Occupational Safety and Health Administration or the Army as a NRTL. It is a self-certification by the party who puts the product on the market in the EU (for example, an EU-based manufacturer, the importer, or distributor of a product made outside the EU, or an EU-based office of a non-EU manufacturer). All electrical equipment marked with CE is considered unlisted and must be inspected, approved, and labeled safe for use by the AHJ prior to use.

*e.* NRTL-listed equipment must be purchased and used if available, even if a less expensive unlisted product is available. Equipment that appears to be of significantly lower cost, is a seasonal product, or is foreign made may have a counterfeit listing. When in doubt, visit the manufacturer's Web site for confirmation.

*f.* All equipment inspected and approved by the AHJ must be labeled with name of inspector and date. If a representative sample of two units that are built identically are inspected and approved, the remainder may be assumed to be comparable and put into use following a visual external inspection.

*g.* All contractors and subcontractors are responsible for the electrical equipment they use. They must assure that the electrical equipment brought into an Army facility is NRTL-listed or approved by a qualified electrical expert.

*h.* All rental equipment must be NRTL-listed or approved by the AHJ, and inspected by an AHJ prior to initial use.

## **Chapter 4**

### **Electrical Workplace Safety Requirements**

#### **4–1. Removal of conductive objects**

Personnel working near exposed, energized electrical conductors or circuit parts will remove all rings, jewelry, watches, and other conductive items before commencing work on energized equipment. Conductive eyeglasses do not need to be removed. If a possible hazard is expected from wearing conductive eyewear, either nonconductive eyewear will be worn or nonconductive goggles will be worn over the eyewear.

#### **4–2. Required personnel**

At a minimum, two qualified persons must be in the immediate area at all times when work is being performed on exposed, energized electrical conductors, or circuit parts carrying 50V or more. Each qualified person must be able to see and hear the other. This ensures that the qualified person will be available to assist the other in case of an accident. Each qualified person will know the location of, have unobstructed access to, and know how to operate the power cutoff for the work area, and how to contact emergency personnel. When hazard levels are significant, a safety watch is required; refer to NFPA 70E or UFC 3-560-01 for specific requirements.

#### **4–3. Working on or near exposed parts**

Safety-related work practices will be integrated in all operations to prevent electric shock or other injuries that could potentially result from either direct or indirect electrical contacts when work is performed near or on equipment or circuits which are or may be energized. The specific safety-related work practices will be consistent with the nature and extent of the associated electrical hazards.

*a. De-energized parts.* Energized electric conductors and/or circuit parts will be de-energized before the employee works within the limited approach boundary and/or the arc flash boundary of the equipment, unless the employer can demonstrate that de-energizing introduces additional or increased hazards or is infeasible due to equipment design or operational limitations. This decision will only be made by a management official with concurrence by the safety office in writing. Energized electric conductors and/or circuit parts with less than 50V to ground do not need to be de-energized if there is no increased exposure to electrical burns or to explosion due to electric arcs.

*Note.* Do not confuse inconvenient with infeasible, as they are not the same.

*b. Energized electric conductors and circuit parts.* In situations where exposed, energized electric conductors or circuit parts are not de-energized because of other safety related issues (for example, for reasons of increased or additional hazards or infeasibility), other safety-related work practices will be used to protect employees that may be exposed to electrical hazards involved. These safety-related work practices will protect employees against contact with energized circuit parts directly with any part of their body or indirectly through some other conductive object. The work practices that are used will be suitable for the conditions under which the work is to be performed and for the

voltage level and/or arc flash incident energy of the exposed electric conductors or circuit parts. Work practices will be included in EEWP.

#### **4-4. Shock protection**

Rubber insulating gloves will be used while conducting exposed, energized electrical work. Use rubber insulating gloves with leather protectors where there is a danger of hand injury from electric shock due to contact with energized electrical conductors or circuit parts. Use rubber insulating gloves with leather protectors and rubber insulating sleeves where there is a danger of hand and arm injury from electric shock due to contact with energized electrical conductors or circuit parts. Rubber insulating gloves will be rated for the voltage to which the gloves will be exposed (see NFPA 70E).

#### **4-5. Tasks requiring two hands**

When both hands are needed for such tasks as voltage measurements, firmly grasp the insulated leads and place them on the test points. When measuring, follow the procedures outlined below. Never work on energized parts when hands, feet, or body are wet or perspiring or when standing on a wet surface.

#### **4-6. Electrical personal protective equipment and protective clothing**

a. When working around potential electrical hazards, personnel will be provided with, and will use, electrical PPE and arc rated protective clothing that is appropriate for the specific parts of the body to be protected and for the work to be performed (see fig 4-1). Appropriate shock protection PPE will be determined by the supervisor and qualified employee. If the incident energy and shock and arc flash hazard are calculated by the AHJ, determine PPE based on NFPA 70E. If not known and PPE is determined by voltage and task, refer to UFC 3-560-01.

b. PPE and protective clothing will be maintained in a safe, reliable condition and will be periodically inspected or tested in accordance with manufacturer's guidance. All inspections and testing will be documented and maintained by the supervisor. If the insulating capability of PPE and protective clothing may be subject to damage during use, the insulating material will be protected (for example, an outer covering of leather is sometimes used for the protection of rubber insulating material). Employees will wear arc rated clothing and PPE that can be provided as an arc flash suit (consisting of an arc flash jacket, pants, and hood), arc rated shirts and pants, or as arc rated coveralls, or as a combination of arc rated jacket and pants, or, for increased protection, as arc rated coveralls with jacket and pants. These combinations of arc rated protection also require an arc rated face shield, balaclava (sock-hood), safety goggles or glasses, hearing protection (ear canal inserts), and heavy duty leather gloves and footwear for arc flash energy up to 12 cal/cm<sup>2</sup>. Where the arc flash incident energy is greater than 12 cal/cm<sup>2</sup>, an appropriately rated arc flash suit with hood will be used. Various weight arc rated fabrics are available. Generally, the higher degree of protection is provided by heavier weight fabrics and/or by layering combinations of one or more layers of arc rated clothing. Work clothes will be made of natural materials, such as cotton or wool, or arc rated materials and will have full-length sleeves. Sleeves will be rolled down and collar buttons fastened for the greatest protection. Additional work-rest cycles will be considered for workers wearing higher levels of PPE.

c. Employees will wear leather shoes or boots that comply with the requirements of the American Society for Testing and Materials International (ASTM) F2413 - 11. No metal parts will be present in the sole, toe, or heel of the shoes where nonconductive shoes are required.

d. Workers will wear approved hardhats when—

- (1) Working above ground on poles, structures, or buildings or in trees.
- (2) Working on the ground near poles, structures, buildings, or trees in which work is being done.
- (3) Visiting or observing in areas where overhead work is being done.

*Note.* Hardhats must be rated per ANSI/International Safety Equipment Association (ISEA) Z89.1 as follows: Type 1 (top head protection); Type 2 (lateral impact head protection); Class E – 20,000V for electrical protection; or Class G – 2,200V for electrical protection.

e. Class C equals no electrical protection. Whenever eyes are in danger of being injured, workers will wear safety glasses or other eye protectors meeting ANSI standards. When the work being performed dictates, workers will wear nonmetallic and nonconductive eye protection. Appropriate PPE is needed to protect workers from arc flash hazards. When protecting from a potential arc flash hazard, safety glasses or goggles will be worn in addition to an arc rated face shield (exposure up to 12 cal/cm<sup>2</sup>) or arc flash hood (exposure greater than 12 cal/cm<sup>2</sup>).

f. Employees will wear gloves, suitable for voltage exposures of 50V to ground or more as required, otherwise suitable work gloves will be worn while handling materials and equipment to prevent the possibility of slivers, cuts, and skin irritation. The following requirements apply for rubber gloves:

(1) Rubber gloves will be of appropriate voltage rating for the work being performed. All rubber gloves will meet the standards set forth by ANSI and ASTM D120 - 09.

(2) Rubber gloves issued for service will be tested at appropriate voltage levels at intervals not exceeding 6 months.

(3) Leather glove protectors will be worn over rubber gloves except where leather protectors are not required by 29 CFR 1910.137 or ASTM F496 - 08. Rubber gloves should be kept inside of leather protectors.

- (4) Rubber gloves will be carried cuff down in a bag, box, or container that is designed for this purpose.
- (5) Rubber gloves will be visually inspected and field air-tested before use each day and at other times if there is cause to suspect damage.
- (6) Rubber gloves will be uniquely identified (for example, serial number or other marking). The results of dielectric tests should be documented for verification and validation.
- (7) Rubber gloves will be wiped clean of any oil, grease, or other damaging substances as soon as possible.

---

### Rubber insulated gloves

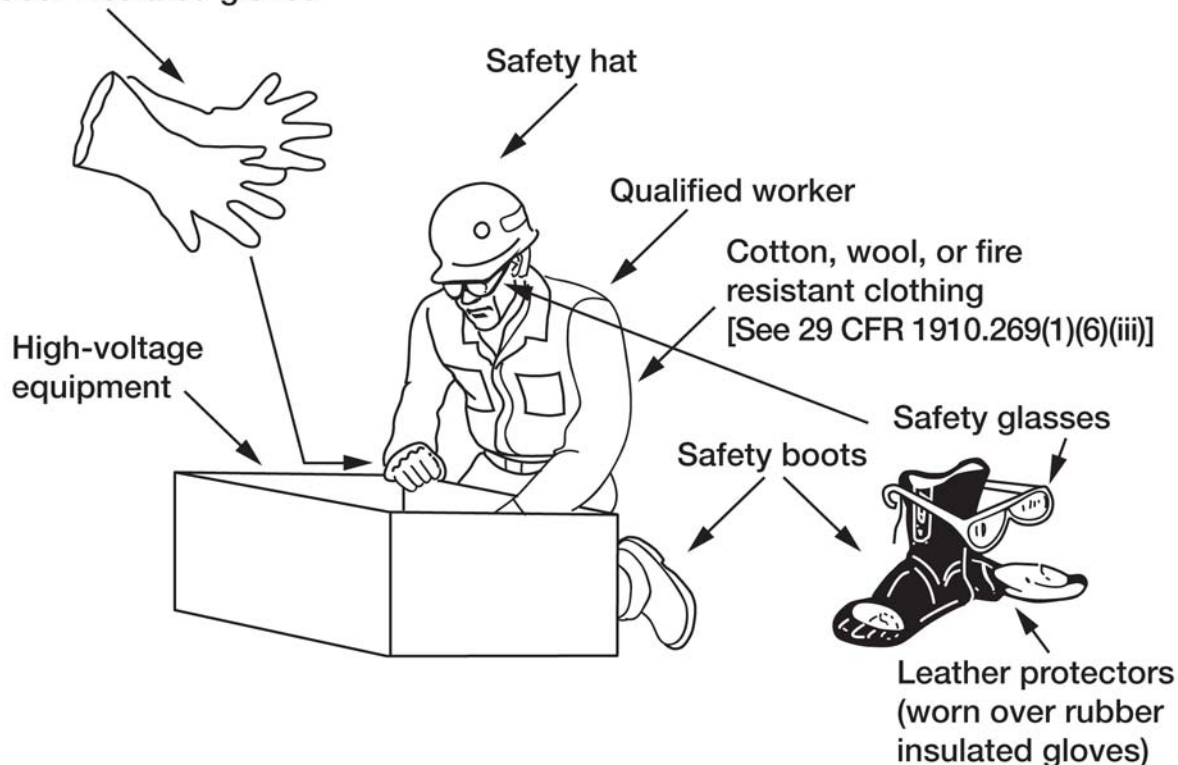

Figure 4-1. Example of an appropriate personal protective equipment and protective clothing for category 0 or 1 range

---

#### 4-7. Clothing systems

All clothing worn by workers working under possible electrical hazard conditions will be considered part of the employees' protective clothing system. This includes rainwear, cold weather wear, and underclothing. Protective clothing will provide a good functional fit to increase the protection and comfort of the clothing. When required for arc flash hazards, protection will be increased by wearing single or multiple layers of arc rated outer garments over non-melting clothing. Sleeves and shirts will be fully buttoned and appropriate neck, head, and hand coverings provided.

#### 4-8. Arc rated clothing

All arc rated fabrics will comply with ASTM F1506 - 10a and NFPA 70E, Article 130. (See NFPA 70E, para 130.5 for details on the arc flash hazard analysis.)

#### 4-9. Electric arc hazards

Electric shock is a widely recognized hazard and involves current flow through or on the body. Burns from electric arcs are not as well recognized. There is no contact required and the burns can be severe, especially if the clothing ignites and continues to burn, or melts. The extent of the employee's injury is dependent on the length of the arc gap, available fault current, duration of the arc, distance of the employee from the arc, percentage of the body burned, employee's age, medical condition, and number of layers of the clothing system. The proper clothing system will minimize or reduce the burn injury.

#### **4-10. Types of arc rated fabrics**

Chemically dependent arc rated fabrics are treated with arc resistant and flame retardant chemicals added to the fiber or treatments applied to the fabric. These treatments are activated by heat and produce gases that smother the flame. Typically, these fabrics have a definite life as defined by the manufacturer. This is usually defined by the number of home or commercial washings and dryings to which the garment is exposed. Inherently arc rated fabrics, by their composition, do not burn in air. The arc rating of this fabric is not affected by washing per the manufacturer's instructions.

#### **4-11. Maintenance and use**

Maintain electrical protective equipment and arc flash clothing and PPE in a safe, reliable condition following the manufacturer's recommendations. Inspect insulating equipment for damage before each day's use and immediately following any incident that can reasonably be suspected of having caused damage. Supervisors will maintain documentation on all inspections. Rubber insulating gloves will be given an air test, along with the inspection. Rubber gloves will be given an air test, along with the inspection. Electrical protective equipment (rubber insulating) will be subjected to periodic electrical tests. Tests voltages and the maximum intervals between tests will be in accordance with ASTM F496 - 08; 29 CFR 1910.137, Table I-6; and NFPA 70E, Table 130.7(C)(7)(c).

#### **4-12. Clean and electrical testing of personnel protective equipment**

Rubber-insulated PPE issued for use will receive periodic cleaning and electrical testing in accordance with the requirements of the appropriate ANSI and/or ASTM standards (see app G). The intervals of retest for rubber goods issued for service will not be more than 6 months for gloves and 12 months for sleeves and blankets. Gloves or sleeves that have been electrically tested but not issued for service will not be placed into service unless they have been electrically tested within the previous 12 months.

*a.* All testing methods, apparatus, and facilities will meet the applicable ANSI and/or ASTM standard. The method used and the results of such tests will be documented in accordance with local standards and made available for inspection.

*b.* Testing apparatus will be operated and maintained by personnel trained for such work. Calibration schedules and procedures for calibrating testing apparatus are recommended to be in accordance with local requirements.

*c.* Retested rubber-insulated PPE will be identified to indicate the date of the latest test or date of retest in accordance with the appropriate standard. Follow the manufacturer's recommendations on the type of paint or ink to be used to mark PPE.

#### **4-13. General protective equipment and tools**

*a.* When working near exposed energized conductors or circuit parts, each employee will use insulated tools or handling equipment. If the insulating capability of insulated tools or handling equipment is subject to damage, the insulating material will be protected.

*b.* Fuse handling equipment, insulated for the circuit voltage, will be used to remove or install fuses when the fuse terminals are energized.

*c.* Ropes and hand lines used near exposed, energized parts will be nonconductive.

*d.* Protective shields, protective barriers, or insulating materials will be used for protection from shock, burns, or other electrically related injuries when working near exposed, energized parts which might be accidentally contacted or where dangerous electric heating or arcing might occur. When normally enclosed live parts are exposed for maintenance or repair, they will be guarded to protect unqualified persons from contact with the live parts.

#### **4-14. Emergency and/or rescue equipment**

DA Pam 40-11 stipulates that the local medical authority must approve the contents, intended use, and maintenance of all first-aid kits and that personnel who may be required to perform first aid must receive approved first-aid training (see DA Pam 40-11).

*a.* Each maintenance facility in which personnel are exposed to 50V or higher will maintain emergency equipment in readily accessible and conspicuous locations and have workers trained in use of the emergency equipment. This equipment will include items for use in electrical emergencies and for first aid to electrical shock victims. Reserve these items for emergencies; they may not be used for routine purposes. Emergency equipment will be inspected monthly to ensure that all items are available and in good condition. Mobile maintenance facilities and transportable maintenance shelters that do not have ready access to a medical facility will be provided with a general purpose first aid kit, national stock number 6545-00-922-1200, if possible.

*b.* Where the eyes or body of any person may be exposed to injurious corrosive materials, suitable facilities for quick drenching or flushing of the eyes and body will be provided within the work area for immediate emergency use (see CFR 29 1910.151(c)).

*c.* Final determination of appropriate emergency and rescue equipment will be determined by local authorities.

#### **4-15. Overcurrent protection**

*a. Circuit de-energized by a circuit protective device.* If a circuit is de-energized by a circuit protective device, the circuit may not be manually re-energized until it has been determined that the equipment and circuit can be safely energized. All personnel (electrical and nonelectrical) must be made aware of this.

*b. Repetitive manual reclosing.* The repetitive manual reclosing of circuit breakers or reenergizing circuits through replaced fuses is prohibited. (See NFPA 70E, Section 130.7(L) and 29 CFR 1910.334(b)(2).)

*c. Reclosing circuits after protective device operation.* After a circuit is de-energized by a circuit protective device, the circuit may not be manually re-energized until it has been determined that the equipment and circuit can be safely energized. When it can be determined from the design of the circuit and the overcurrent devices involved that the automatic operation of a device was caused by an overload rather than a fault condition, no examination of the circuit or connected equipment is needed before the circuit is re-energized.

*d. Modifying or bypassing overcurrent protection.* Overcurrent protection of circuits and conductors may not be modified or bypassed, even on a temporary basis, unless directed by maintenance instructions in the system technical manual or the overcurrent protection has been developed and approved under engineering supervision.

*e. Failure due to overload.* When it can be determined by a qualified person (for example, engineer, electrician, or so forth) from the design of the circuit and the overcurrent devices involved that the automatic operation of a device was caused by an overload rather than a fault condition, no examination of the circuit or connected equipment is needed before the circuit is re-energized.

*f. Failure due to a fault.* If it is determined that the circuit breaker opened under fault conditions, it must be removed from service for inspection and electrical testing to verify reliability and safety before placing it back in service. Failure to do this can have a dramatic impact on the available arc flash energy.

#### **4-16. Electrical service failure**

In the event that electrical service fails while power is being applied to either the equipment being maintained or that tested, measured, and used as diagnostic equipment—

*a.* Turn all equipment and test, measurement, and diagnostic equipment power switches to the OFF position.

*b.* Open the circuit breakers of the power source, where practical.

*c.* After service is restored, check that the equipment switches are in the OFF position before closing the circuit breakers.

## **Chapter 5**

### **Electrical Safety in Army Facilities, Installations, and Infrastructures**

#### **5-1. Introduction**

Electrical safety requirements for Army facilities, installations, and infrastructures will be implemented in accordance with 29 CFR 1910, Subpart S; NFPA 70E; NFPA 70 (NEC); and UFC 3-560-01. These general guidelines are highlighted to protect Army personnel, equipment, and facilities.

#### **5-2. Grounding**

This paragraph focuses on grounding requirements for all Army systems, circuits, and equipment (see apps E and F for basic grounding and grounding path requirements and information). Systems that supply premises wiring will be grounded as follows:

*a.* All three-wire DC systems will have their neutral conductor grounded.

*b.* Two-wire DC systems operating at over 50V through 300V between conductors will be grounded unless they supply only industrial equipment in limited areas and are equipped with a ground detector; they are rectifier-derived from an AC system complying with 29 CFR 1910.304(g)(1)(iii), (g)(1)(iv), and (g)(1)(v); or they are fire-alarm circuits having a maximum current of 0.030 amperes.

*c.* AC systems of 50V to 1000V will be grounded as follows:

(1) The system can be so grounded that the maximum voltage to ground on the ungrounded conductors does not exceed 150V.

(2) If the system is nominally rated three-phase, four-wire connected in which the neutral is used as a circuit conductor; if the system is nominally rated three-phase, four-wire delta connected in which the midpoint of one phase is used as a circuit conductor; or if a service conductor is uninsulated.

*d.* AC systems of 50V to 1000V are not required to be grounded under any of the following conditions if the system is:

(1) Used exclusively to supply industrial electric furnaces for melting, refining, tempering, and the like.

(2) Separately derived and is used exclusively for rectifiers supplying only adjustable speed industrial drives.

(3) Separately derived and is supplied by a transformer that has a primary voltage rating less than 1000V, provided

all of the system is used exclusively for control circuits; the conditions of maintenance and supervision ensure that only qualified persons will service the installation; continuity of control power is required; and ground detectors are installed on the control system.

### **5-3. Facility grounding systems**

Facility grounding systems must be installed and maintained in accordance with NFPA 70 (NEC). All grounding points within a facility will be electrically continuous to a grounding (earth) electrode. The resistance measured from the facility's most remote grounding point to each electrode should not exceed 2 ohms. The resistance of the grounding electrode to earth should not exceed 25 ohms.

*a.* Mobile facilities will be grounded in accordance with their operating instructions. If used, the power generator will be grounded to a ground system. If the generator and vehicle are sited less than 25 ft (7.6 m) apart, either a common ground will be used or the two ground systems will be connected with bare copper cable, American wire gauge #6 or larger. If commercial power is used, the vehicle will be grounded to the commercial ground conductor at the first service disconnect.

*b.* Metal frames of electric equipment and tools, such as handheld power tools, must be connected to a grounding conductor (for example, they must contain a three-wire power cord and plug). Portable tools that are protected by an approved insulation system (listed by Underwriter's Laboratory or equivalent) need not be grounded.

*c.* Maintenance activities will maintain a file of up-to-date descriptions of all facility grounding installations, such as construction specifications and drawings, blueprints, work orders, and so forth. Installation engineers or other qualified personnel (as determined by local policy) should annually inspect grounding systems for compliance with appropriate standards, including conductor continuity. Continuity inspections should be made with a low-resistance ohmmeter. This will include nonpermanent facilities.

*d.* DA Pam 385-64 augments these requirements for grounding operations in explosive safety operations.

### **5-4. Bonding**

Caution will be taken to ensure that the main bonding jumper and equipment bonding jumper are sized and selected correctly. (See NFPA 70 (NEC), Article 250.) Bonding completes the grounding circuit so that it is continuous. If a ground fault occurs, the fault current will flow and open the overcurrent protection devices. The means of bonding will provide the following to ensure the grounding system is intact:

*a.* A permanent connection.

*b.* A positive continuity at all times.

*c.* Ampacity to conduct fault current.

### **5-5. Temporary wiring**

*a.* All requirements for permanent wiring in 29 CFR 1910, Subpart S and NFPA 70 will also apply to temporary wiring in all Army facilities, installations, and operations. Remove temporary wiring immediately upon completion of the project or purpose for which the wiring was installed. Use temporary electrical installations of more than 600V only during periods of tests, experiments, emergencies, or construction-like activities.

*b.* Use temporary electrical power and lighting installations of 600V, nominal, or less only during remodeling, maintenance, or repair of buildings, structures, or equipment, and similar activities; for a period not to exceed 90 days for Christmas decorative lighting, carnivals, and similar purposes; or for experimental or development work and during emergencies.

*c.* Local regulations and/or SOPs, designs, and temporary structure plans will address temporary wiring methods and limitations, to include branch circuits, grounding requirements, receptacles disconnecting switches, and plug connectors.

*d.* Only grounding type receptacles will be used. Unless installed in a continuous grounded metallic raceway or metallic covered cable, each branch circuit will contain a separate equipment grounding conductor and all receptacles will be electrically connected to the grounding conductor.

*e.* Protect flexible cords and cables from accidental damage.

*f.* Support cable assemblies and flexible cords and cables in place at intervals that ensure that they will be protected from physical damage. Support will be in the form of staples, cables ties, straps, or similar type fittings installed so that they will not cause damage.

*g.* Use military equipment with temporary-type wiring, released under the provisions of AR 700-142, in accordance with the technical manual instructions.

### **5-6. Electrical panel-boards**

Keep electrical panels and/or box doors shut at all times. All circuits and circuit modifications will be legibly identified as to purpose or use on a circuit directory located on the face or inside of the panel door. Only qualified personnel will open or close electrical panel and/or box doors or touch any circuit breakers. Maintain proper clearance around



electrical panels and/or box (36 in (.9 m) (depth), 30 in (.76 m) (width) and 6.5 ft (1.98 m) (height) in most situations (see NFPA 70 (NEC), Article 110 for details) in front of panel door) and locate it so that it is not exposed to physical damage.

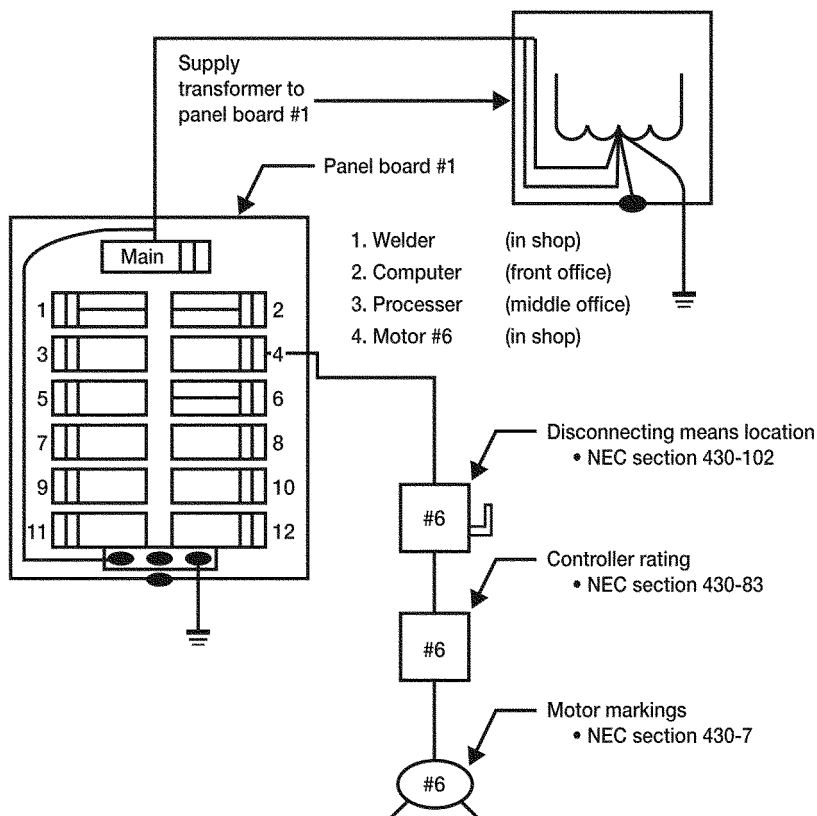

Figure 5-1. Example of switch gear, panel boards, and motor control centers

### 5-7. Uses of equipment when flammable materials and/or atmospheres are present

When flammable materials or atmospheres are present, electrical equipment that is NRTL-listed for use in such environments or approval by the AHJ will be used to prevent hazardous conditions from developing. In areas where flammable liquids are stored or used, electrical equipment, wiring, switches, and so forth will meet the requirements of NFPA 70 (NEC).

### 5-8. Hazardous (classified) locations

a. The locations of electrical equipment and wiring will be classified depending on the properties of the flammable vapors, liquids or gases, or combustible dusts or fibers that may be present. In classifying locations, each room, section, or area will be classified on an individual basis in accordance with NFPA 70 (NEC), Article 235 and Article 500; 29 CFR 1910.307; and/or Engineer Manual 385-1-1, table 11-2.

b. All hazardous (classified) locations within a facility and/or activity will be documented by the immediate supervisor responsible for the hazardous (classified) location.

c. All threaded conduit will be threaded with a National (American) Standard Pipe Taper standard conduit cutting die that provides 3/4-in taper per foot. The conduit will be made wrench tight to prevent sparking when fault current flows through the conduit system and to ensure the explosion proof or flame proof integrity of the conduit system where applicable. Equipment provided with threaded entries for field wiring connection will be installed in accordance 29 CFR 1910.307(g)(2)(iv)(A) or (g)(2)(iv)(B).

d. All electric and electronic equipment in hazardous locations will be protected at all times. The appropriate protection techniques will be used based on classification as listed in 29 CFR 1910.307(g)(3).

e. All equipment, wiring methods, and installations of equipment in hazardous (classified) locations will be listed either as intrinsically safe, listed for the hazardous location, or demonstrated to be safe for the location.

f. Equipment and wiring listed for the hazardous (classified) location will be approved for class of location and for ignitable or combustible properties of the specific gas, vapor, dust, or fiber that will be present. Equipment will be marked to identify class, group, and operating temperature or temperature range for which it is approved.

### **5-9. Defective or damaged equipment**

When a defect or evidence of damage that can cause an electrical hazard is found, the defective or damaged item will be removed from service and reported to the appropriate authorities. Use is prohibited until repairs and tests necessary to render the equipment safe are completed.

### **5-10. Spaces and/or clearances about electrical and/or electronic equipment**

Sufficient access, working space, and illumination will be provided and maintained about all electric equipment to permit ready and safe operation and maintenance of such equipment. At least one entrance of sufficient area will be provided to give access to the working space.

a. Work space distances will be measured from the live parts if exposed or from the enclosure front or opening if live parts are enclosed.

*Note.* Concrete, brick, or tile walls are considered to be grounded.

b. Where live parts are normally exposed on the front of equipment, working space in front of such equipment may not be less than 3 ft (.9 m).

c. Workspace width may not be less than 30 in (76.2 cm) wide in front of the equipment or the width of the equipment, whichever is greater. In all cases, the working space will permit at least a 90-degree opening of equipment doors or hinged panels.

d. Working space is not required in back of assemblies where there are no renewable or adjustable parts such as fuses or switches on the back and where all connections are accessible from locations other than the back.

e. Working space may not be used for storage.

f. When normally enclosed live parts are exposed for inspection or servicing, the working space, if in a passageway or general open space, will be suitably guarded to prevent injury to personnel entering the area.

g. Proper illumination will be provided for all working and/or maintenance spaces.

h. Where provision of these working spaces is not practicable (for example, on the interior of shelters or similar equipment) address the hazard in the job briefing and consider additional hazard controls, such as an assistant and/or safety watch.

### **5-11. Emergency equipment**

Emergency equipment will be maintained in the facility as determined by local emergency authority and personnel will be trained in use of such equipment.

## **Chapter 6 Electrical Safety in Contingency Base Operations**

### **6-1. General**

All personnel will be protected from electrical related hazards. All leaders at each echelon of contingency base operations will ensure risk assessments identify electrical hazards and ensure appropriate controls are implemented to mitigate electrical risk. All components of contingency base operations will comply with Federal, Department of Defense, and Army electrical standards including all chapters in this pamphlet. Components of contingency base operations will not provide an unsafe condition or unnecessary risk to personnel. Electrical safety SOPs will be developed by the appropriate components in conjunction with local safety offices and must prescribe electrical safety policy, procedures, and responsibilities in identifying and mitigating electrical safety hazards and use of electrical equipment in local contingency base operations.

a. Force provider expeditionary (FPE) shelters' electrical devices (for example, circuits, receptacles, cord connectors, switches, and so forth) and wiring will be grounded in accordance with NFPA 70 (NEC). Ground fault protection will be provided, as required by NFPA 70 (NEC), especially when within 6 ft (1.8 m) of water or wet areas. All electrical wiring and any live parts will be protected and covered in accordance with NFPA 70 (NEC). Lightning protection will be installed in all FPE shelters in accordance with NFPA 780. This is implemented to protect personnel and FPE shelters against lightning related hazards.

b. System safety engineers will ensure electrical standards are met during review of all components of the FPE shelter at each development stage and prior to fielding.

c. Risk assessments will be conducted prior to placement of FPE shelters in accordance with DA Pam 385-30.

*d.* Equipment will be NRTL-listed and used as intended, or inspected and approved as safe for intended use by the AHJ.

## **6–2. Applications of contingency construction standards for electrical installations**

*a.* Contingency construction standards for electrical installations are designed to safeguard life or limb, health, property, and welfare by regulating the design, construction, and installation of electrical systems and equipment.

*b.* Personnel, companies, or units will not erect, construct, alter, extend, repair, move, remove, or demolish electrical systems in any facility without prior approval from the base operations support commander or designated representative.

*c.* The Base Camp Master Plan construction standard will regulate the design, construction, and installation of electrical systems as the project pertains to initial, temporary, or semi-permanent contingency construction. All contingency construction must meet basic safety requirements for bonding, grounding, and safe building practices.

*d.* All workers, including contractors, will comply with the requirements in UFC 3–560–01. This includes safe clearance and lockout and/or tagout procedures, and arc flash PPE requirements.

*e.* Electrical work will be inspected and tested by a qualified electrician before occupancy or acceptance of the electrical work. The inspection will be commensurate with United States and host nation requirements, as applicable. No person will make connections from a utility, source of energy, fuel, or power to any building or system that has not been inspected and accepted by a qualified person that has conducted such tests to ensure buildings are in compliance with the construction standards.

*f.* All manufactured buildings will have a single point to disconnect power at the service entry.

*g.* All electrical work will comply with either the host nation’s code, NFPA 70 (NEC), or the British Standard (BS) 7671. In general, the host nation code will be used in countries with an existing electrical code; NFPA 70 (NEC) will be used in countries where 60 hertz (Hz) power is predominant (but the country does not have an established electric code); and BS 7671 will be used in countries where 50 Hz power is predominant (but no electric code exists). In any of these instances it is possible to use NFPA 70 (NEC) if the command deems necessary. Where there is conflict between a general requirement and a specific requirement, the more stringent requirement will be applicable. In any instances where wiring based on different codes will be joined, the different codes will be documented and forwarded through the base operations support commander to the appropriate Service representative of the Tri-Service Electrical Working Group (TSEWG) for a decision as to which code will be used before work commences.

*h.* For any expeditionary operating area, a task force will be established with the mission of accessing and analyzing fire and electrical safety issues and directing action to reduce risk. The organization will have master electricians versed in other codes’ (for example, BS 7671) requirements for bonding and grounding, and they will be utilized as the Government’s quality assurance for electrical work in theater. At a minimum, fault current calculations and grounding impedance readings will be included as part of acceptance testing. The contractor who provides these assets must not be the contractor currently contracted to perform the electrical work.

*i.* A theater arbitration cell may be created and staffed to provide oversight for electrical work associated with contingency construction and maintenance-related projects which cannot comply with NFPA 70 (NEC). The theater arbitration cell will also include AHJ personnel. The AHJ personnel will process and review deviation requests. The AHJ personnel will forward the deviation request and recommendations to the TSEWG for final risk determination and acceptance. The TSEWG is responsible for all Department of Defense unified electrical criteria. The theater Army Service component command will be responsible for coordinating with TSEWG and disseminating and maintaining records of all deviation rulings.

*j.* Bonding and grounding of explosive and ammunition facilities and operations will be in accordance with AR 385–64 and supporting regulations.

## **Chapter 7 Tactical Electrical Safety**

### **7–1. Introduction**

In Army tactical operations, personnel may encounter electrical services and equipment that do not meet established safety standards. As much of the intrinsic safety in electrical services and equipment relies on compliance to safety standards, additional electrical hazards are often present with noncompliant systems. Additional precautions are necessary.

### **7–2. Tactical operations**

Leaders will consider electrical hazards in tactical operations and integrate these into composite risk management techniques. Chapter 2 requirements will apply.

### 7-3. Additional hazards and precautions

*a. Army equipment.* All Army tactical electrical equipment will be used in accordance with the system technical manuals, including maintenance instructions.

*b. Commercial equipment.* Commercial electrical equipment used in tactical operations will be used in accordance with manufacturer's instructions and precautions. Temporary wiring will comply with chapter 4 and the NFPA 70 (NEC), or approved electrical safety standards used in theater.

*c. Low hanging and uninsulated power lines.* Power lines and exposed electrical parts will be treated as energized and avoided, with personnel keeping 20 ft (6 m) away. See paragraphs 3-8 through 3-10 for more information on approach distances.

*d. Host nation electrical services and equipment.* Electrical equipment outside of the continental United States has different voltages and other characteristics. These services may not be grounded and may lack basic electrical safety safeguards. Do not use host nation electrical services, equipment, and facilities unless competent authority determines that it is safe to do so. See chapter 5 for additional information. Electrical equipment and services are generally unsafe if—

- (1) Covers are removed or wiring or other parts are exposed.
- (2) Equipment is excessively hot or produces smoke or burning smell.
- (3) The equipment gives a shock. A shock means the equipment surface is energized and dangerous. Nonelectrical equipment, such as plumbing, may become energized from unsafe electrical systems.

*Note.* Do not use any equipment or systems if there is any sensation of shock.

Report it immediately and safeguard it from use through barriers and signs until qualified personnel can de-energize or perform repairs.

*e. Tactical radio antennas.*

(1) Follow precautions found in system technical manuals. If unknown, keep antenna masts twice their height away from power lines and other exposed electrical parts.

(2) Keep antenna profile down as low as possible for vehicular and man-pack radio antennas. Tie vehicle mounted antennas where possible. Do not try to grab or hold the antenna down during movement.

*Note.* Antenna contact with power lines or other energized parts is lethal.

- (3) Do not assume plastic or fiberglass-coated antennas are safe for power line contact.
- (4) If electrical wire contact occurs—
  - (a) While in a vehicle, do not exit the vehicle unless it is immobile or on fire. Do not touch the antenna. Move the vehicle to break contact.
  - (b) And exit is necessary, do not touch the ground and vehicle at the same time. Land with both feet together and shuffle in small steps to avoid step potential hazards from electrified ground. Be careful to maintain balance.
  - (c) Do not render aid to victims until power is off or contact is removed and the area is safe to enter. You will become a victim if you contact an electrified victim or vehicle.

*f. Batteries.* Follow precautions and safety instructions provided with military batteries. Follow manufacturer's instructions and precautions with commercial batteries. If no precautions or instructions are provided the following guidance will be used:

- (1) Do not short battery terminals. This produces a risk of fire and/or explosion. Protect exposed terminals on batteries from contact.
- (2) Do not mix used and new batteries.
- (3) Do not mix battery of different chemistries (for example, lithium and alkaline).
- (4) Do not puncture batteries.
- (5) Do not expose batteries to excessive heat or fire.
- (6) Dispose of batteries in accordance with locally established SOPs.

## **Appendix A References**

### **Section I**

#### **Required Publications**

Unless otherwise stated, all publications are available on the Army Publishing Directorate Web site at <http://www.apd.army.mil/>.

#### **AR 385-10**

The Army Safety Program (Cited in para 1-3.)

#### **DA Pam 385-10**

Army Safety Program (Cited in paras 1-8, 3-6a.)

#### **Engineer Manual 385-1-1**

Safety and Health Requirements (Cited in paras 1-2, 5-8a.)  
(Available at <http://publications.usace.army.mil/publications/eng-manuals/>.)

#### **29 CFR 1910**

Occupational Safety and Health Standards (Cited in paras 1-2, 3-6a, 3-8a(2), 3-10a, 4-6g(3), 4-11, 4-14b, 4-15b, 5-1, 5-2b, 5-5a, 5-8, C-5.) (Available at <http://www.gpo.gov/fdsys/>.)

#### **29 CFR 1926.417**

Lockout and tagging of circuits (Cited in para 3-6a.) (Available at <http://www.gpo.gov/fdsys/>.)

#### **UFC 4-021-01**

Design and O&M: Mass Notification Systems (Cited in para 1-2.) (Available at <http://www.wbdg.org/>.)

### **Section II**

#### **Related Publications**

A related publication is a source of additional information. The user does not have to read a related reference to understand this publication. ANSI publications are available for purchase from <http://www.ansi.org>. ASTM publications are available for purchase from <http://www.astm.org>. NFPA publications are available for purchase from <http://www.nfpa.org>.

#### **AR 608-1**

Army Community Service Center

#### **AR 700-142**

Type Classification, Materiel Release, Fielding, and Transfer

#### **DA Pam 40-11**

Preventive Medicine

#### **DA Pam 385-30**

Mishap Risk Management

#### **DA Pam 385-40**

Army Accident Investigations and Reporting

#### **DA Pam 385-64**

Ammunition and Explosives Safety Standards

#### **ANSI ASC A14.1-2007**

American National Standard for Ladders – Wood Safety Requirements

#### **ANSI ASC A14.3-2008**

American National Standard for Ladders – Fixed-Safety Requirements

**ANSI ASC A14.4–2009**

American National Standard Safety Requirements for Job Made Wooden Ladders

**ANSI ASC A14.5–2007**

American National Standard for Ladders – Portable Reinforced Plastic – Safety Requirements

**ANSI/International Safety Equipment Association (ISEA) Z87.1–2010**

American National Standard for Occupational and Educational Personal Eye and Face Protection Devices

**ANSI/ISEA Z89.1 – 2009**

American National Standard for Industrial Head Protection

**ANSI Z535 series**

Safety Color Code

**ANSI Z535.2 – 2011**

Environmental and Facility Safety Signs

**ASTM D120 – 09**

Standard Specification for Rubber Insulating Gloves

**ASTM D1048 – 12**

Standard Specification for Rubber Insulating Blankets

**ASTM D1049 – 98 (2010)**

Standard Specification for Rubber Insulating Covers

**ASTM D1050 – 05 (2011)**

Standard Specification for Rubber Insulating Line Hose

**ASTM D1051 – 08**

Standard Specification for Rubber Insulating Sleeves

**ASTM F478 – 09**

Standard Specification for In Service Care of Insulating Line Hose and Covers

**ASTM F479 – 06 (2011)**

Standard Specification for the Service Care of Insulating Blankets

**ASTM F496 – 08**

Standard Specification for In-Service Care of Insulating Gloves and Sleeves

**ASTM F696 – 06 (2011)**

Standard Specification for Leather Protectors for Rubber Insulating Gloves and Mittens

**ASTM F711 – 02 (2007)**

Standard Specification for Fiberglass Reinforced Plastic (FRP) Rod and Tube Used in Live Line Tools

**ASTM F712 – 06 (2011)**

Standard Test Methods and Specifications for Electrically Insulating Plastic Guard Equipment for Protection of Workers

**ASTM F855 – 09**

Standard Specifications for Temporary Protective Grounds to Be Used on De-energized Electric Power Lines and Equipment

**ASTM F887 – 12e1**

Standard Specifications for Personal Climbing Equipment

**ASTM F1117 – 03 (2008)**

Standard Specification for Dielectric Footwear

**ASTM F1236 – 96 (2012)**

Standard Guide for Visual Inspection of Electrical Protective Rubber Products

**ASTM F1505 – 10**

Standard Specification for Insulated and Insulating Hand Tools

**ASTM F1506 – 10a**

Standard Performance Specification for Flame Resistant and Arc Rated Textile Materials for Wearing Apparel for Use by Electrical Workers Exposed to Momentary Electric Arc and Related Thermal Hazards

**ASTM F1742 – 03 (2011)**

Standard Specification for PVC Insulating Sheeting

**ASTM F1891 – 12**

Standard Specification for Arc and Flame Resistant Rainwear

**ASTM F2178 – 12**

Standard Test Method for Determining the Arc Rating and Standard Specification for Face Protective Products

**ASTM F2249 – 03 (2009)**

Standard Specification for In-Service Test Methods for Temporary Grounding Jumper Assemblies Used on De-energized Electric Power Lines and Equipment

**ASTM F2412 – 11**

Standard Test Methods for Foot Protection

**ASTM F2413 – 11**

Standard Specification for Performance Requirements for Protective (Safety) Toe Cap Footwear

**ASTM F2522 – 12**

Standard Test Method for Determining the Protective Performance of a Shield Attached on Live Line Tools or on Racking Rods for Electric Arc Hazards

**ASTM F2676 – 09**

Standard Test Method for Determining the Protective Performance of an Arc Protective Blanket for Electric Arc Hazards

**ASTM F2677 – 08a**

Standard Specification for Electrically Insulating Aprons

**BS 7671**

Requirements for Electrical Installations (Available for purchase from <http://www.standardscentre.co.uk>.)

**NFPA 70**

National Electrical Code®

**NFPA 70E**

Standard for Electrical Safety in the Workplace®

**NFPA 780**

Standard for the Installation of Lightning Protection Systems

**Technical Bulletin 385-4**

Safety Requirements for Maintenance of Electrical and Electronic Equipment

**UFC 3-560-01**

Electrical Safety, O&M (Available at <http://www.wbdg.org/>.)

## 10 USC 1588

Authority to accept certain voluntary services (Available at <http://uscode.house.gov/>.)

### Section III

#### Prescribed Forms

This section contains no entries.

### Section IV

#### Referenced Forms

Unless otherwise indicated, DA forms are available on the Army Publishing Directorate Web site at <http://www.apd.army.mil/>.

#### DA Form 2028

Recommended Changes to Publication and Blank Forms

## Appendix B

### Grounding of Equipment Connected by Cord and Plug

#### B-1. Grounding

*a.* Under any of the conditions described below, exposed noncurrent-carrying metal parts of cord- and plug-connected equipment which may become energized will be grounded:

- (1) If in a hazardous (classified) location.
- (2) If operated at over 150V to ground, except for guarded motors and metal frames of electrically heated appliances if the appliance frames are permanently and effectively insulated from ground.
- (3) If the equipment is of the following types:
  - (*a*) Refrigerators, freezers, and air conditioners.
  - (*b*) Clothes-washing, clothes-drying, and dishwashing machines, sump pumps, and electrical aquarium equipment.
  - (*c*) Hand-held motor-operated tools.
  - (*d*) Motor-operated appliances of the following types: hedge clippers, lawn mowers, snow blowers, and wet scrubbers.
  - (*e*) Cord- and plug-connected appliances used in damp or wet locations or by employees standing on the ground or on metal floors or working inside of metal tanks or boilers.
  - (*f*) Portable and mobile X-ray and associated equipment.
  - (*g*) Tools likely to be used in wet and conductive locations.
  - (*h*) Portable hand lamps.
- b.* See paragraph B-2 for conditions of exposed electrical equipment.

#### B-2. Exposed electrical equipment

Under the conditions described above, exposed noncurrent-carrying metal parts of cord- and plug-connected equipment must be grounded. Grounding metal parts is not required where the equipment is supplied through an isolating transformer with an ungrounded secondary transformer of not over 50V or if portable tools are protected by an approved system of double insulation. To ground cord- and plug-connected equipment, a third wire is commonly provided in the cord set and a third prong in the plug. The third wire serves as an equipment grounding conductor which is connected to the metal housing of a portable tool and a metal grounding bus inside the service entrance equipment. The service entrance equipment is located at the entrance point of the electric supply for a building or plant and contains, or serves, other panelboards which contain branch circuit protective devices such as fuses and circuit breakers. The third wire provides a path for fault current should an insulation failure occur. In this manner, dangerous fault current will be directed back to the source, the service entrance, and will enable circuit breakers or fuses to operate, thus opening the circuit and stopping the current flow.

#### B-3. Grounding conductor

Figure B-1 illustrates the potential shock hazard that exists when no third wire (grounding conductor) is used. If a fault occurs, most of the current will follow the path of least resistance. If the worker provides a path to ground as shown, some portion of the current will flow away from the grounded white conductor (neutral) and return to ground through the worker. The severity of the shock received will depend on the amount of current that flows through the worker. Figure B-2 illustrates the advantage of a properly connected grounded conductor. Properly bonded conduit and associated metal enclosures can also serve as a grounding conductor.



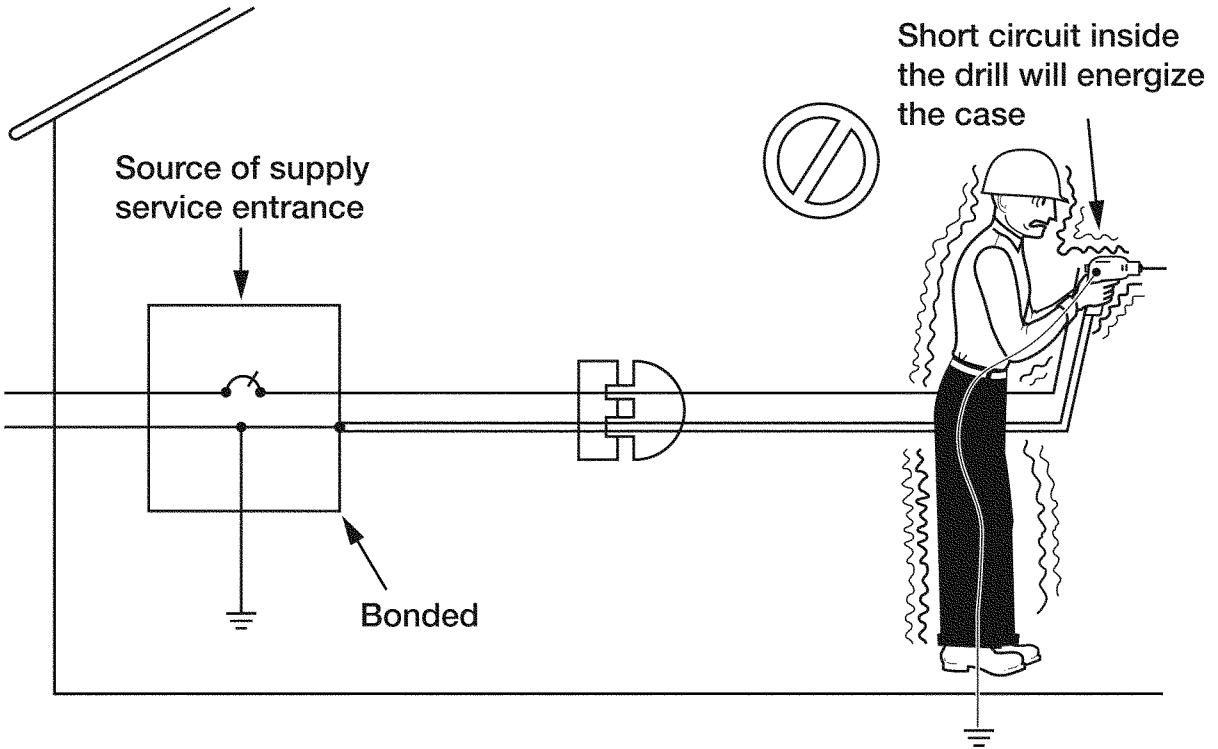

Figure B-1. Cord- and plug-connected equipment without a grounding conductor

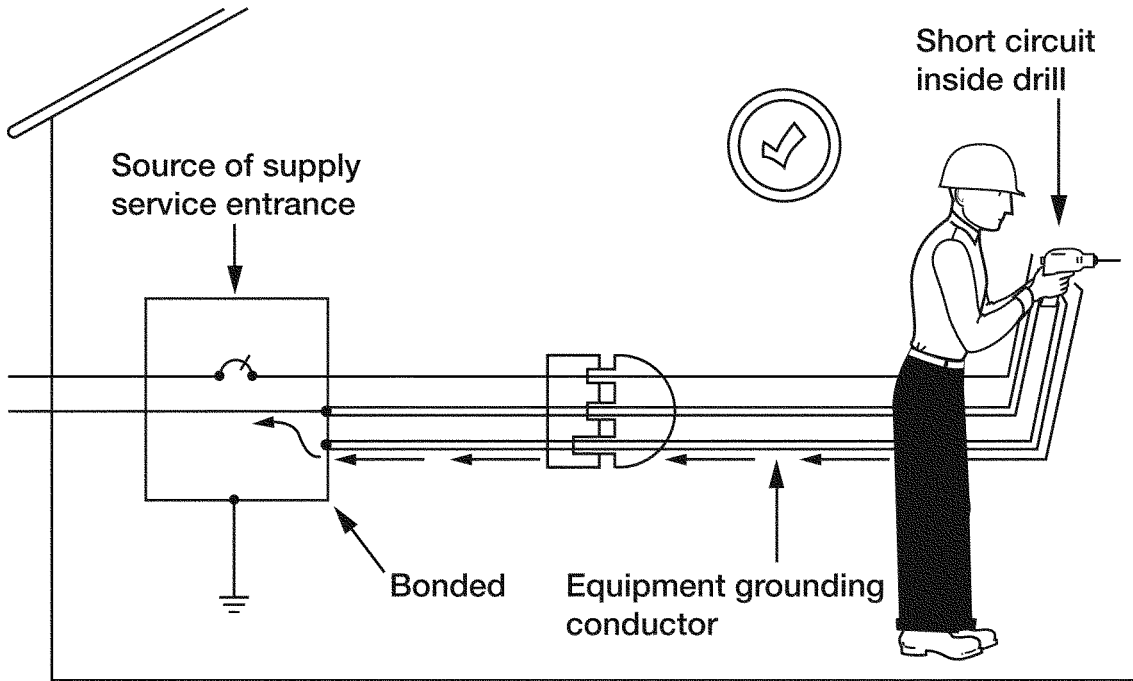

Figure B-2. Cord- and plug-connected equipment with a grounding conductor

## Appendix C Ground Fault Circuit Interrupters

### C-1. General

In most cases, insulation and grounding are used to prevent injury from electrical wiring systems or equipment. However, there are instances when these recognized methods do not provide the degree of protection required. To emphasize the importance of GFCIs (see fig C-1), below are examples of instances where GFCIs would provide additional protection.

*a.* Many portable hand tools, such as electric drills, are now manufactured with nonmetallic cases. If approved by a NRTL (for example, American National Safety Institute, Underwriters Laboratory, and so forth), such tools are referred to as double insulated. Although this design method assists in reducing the risk from grounding deficiencies, a shock hazard can still exist. In many cases, personnel must use such electrical equipment where there is considerable moisture or wetness. Although the person is insulated from the electrical wiring and components, there is still the possibility that water can enter the tool housing. Ordinary water conducts electricity. Therefore, if the water contacts energized parts, a path will be provided from inside the housing to the outside, bypassing the double insulation. When a person holding a hand tool under these conditions touches another conductive surface in the work environment, an electric shock will result.

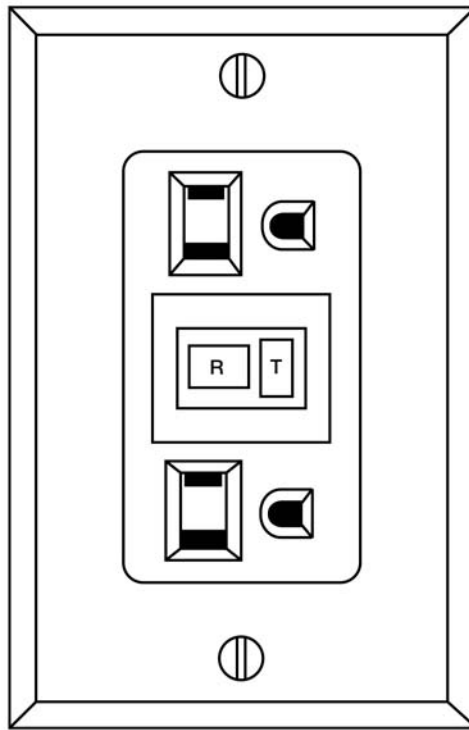

Figure C-1. Electrical outlet equipped with a ground fault circuit interrupter

---

*b.* Double-insulated equipment or equipment with nonmetallic housings that do not require grounding under NFPA 70 (NEC) is used frequently around sinks or in situations where the equipment could be dropped into water. In many cases, the initial human response is to grab for the equipment. If a person's hand is placed in the water and another portion of the body is in contact with a conductive surface, a serious or deadly electric shock can occur.

*c.* In construction work and regular factory maintenance work, it is frequently necessary to use extension cord sets with portable equipment. These cords are regularly exposed to physical damage. Although safe work procedures require adequate protection, it is not possible to prevent all damage. Frequently, the damage is only to the insulation, exposing energized conductors. It is not unusual for a person to handle the cord often with the possibility of contacting the exposed wires while holding a metal case tool or while in contact with other conductive surfaces.

d. The amount of current which flows under such conditions will be enough to cause serious human response. This can result in falls or other physical injury and, in many cases, death.

e. Since neither insulation (double insulation) nor grounding can provide protection under these conditions, it is necessary to use other protective measures. One acceptable method is a GFCI.

### **C-2. How ground fault circuit interrupters work**

a. A GFCI is not an overcurrent device like a fuse or circuit breaker. GFCIs are designed to sense an imbalance in current flow over the normal path. It is a device that protects personnel by de-energizing a circuit, or portion of a circuit, when the current to ground exceeds a specific value.

b. The GFCI contains a special sensor that monitors the strength of the magnetic field around each wire in the circuit when current is flowing. The magnetic field around a wire is directly proportional to the amount of current flow, thus the circuitry can accurately translate the magnetic information into current flow.

c. A GFCI compares the amount of current flowing between hot (black) to neutral (white). If there is any imbalance, it trips the circuit. It is able to sense a mismatch as small as 5 + 1 milliamperes (mA), and it can react as quickly as 1/40 of a second.

### **C-3. Types of ground fault circuit interrupters**

There are several types of GFCIs available, with some variations to each type. Although all types will provide ground fault protection, the specific application may dictate one type over another.

a. *Circuit breaker type.* Includes the functions of a standard circuit breaker with the additional functions of a GFCI. It is installed in a panelboard and can protect an entire branch circuit with multiple outlets. It is a direct replacement for a standard circuit breaker of the same rating.

b. *Receptacle type.* Incorporates within one device one or more receptacle outlets protected by the GFCI. Such devices are becoming popular because of their low cost. Most are of the duplex receptacle configuration and can provide GFCI protection for additional non-GFCI type receptacles connected "downstream" from the GFCI unit.

c. *Permanently mounted type.* Mounted in an enclosure and designed to be permanently wired to the supply. Frequently, they are used around large commercial swimming pools or similar wet locations.

d. *Portable type.* Several styles are available. The portable types are designed to be easily transported from one location to another. They usually contain one or more integral receptacle outlets protected by the GFCI module. Some models are designed to plug into existing non-GFCI protected outlets or, in some cases, are connected with a cord- and plug-arrangement. The portable type also incorporates a no-voltage release device which will disconnect power to the outlet if any supply conductor is open. Units approved for use outdoors will be in enclosures suitable for the environment. If exposed to rain, they must be listed as rainproof.

e. *Cord-connected type.* Consists of an attachment plug which incorporates the GFCI module. It provides protection for the cord and any equipment attached to the cord. The attachment plug has a nonstandard appearance and is equipped with Test and Reset buttons. Like the portable type, it incorporates a no-voltage release device which will disconnect power to the load if any supply conductor is open.

### **C-4. Classes of ground fault circuit interrupters**

GFCIs are divided into two classes: Class A and Class B. The Class A device is designed to trip when current flow, in other than the normal path, is 6mA or greater. The specification is  $5\text{mA} \pm 1\text{mA}$ . The Class B device will trip when current flow, in other than the normal path, is 20mA or greater. Class B devices are approved for use on underwater swimming pool lighting installed prior to the adoption of NFPA 70 (NEC) in 1965.

### **C-5. Testing ground fault circuit interrupters**

Due to the complexity of a GFCI, it is necessary to test the device on a regular basis. For permanently wired devices, a monthly test is required per the listing and labeling requirements of the device (see NFPA 70 (NEC), Section 110.3(B) and 29 CFR 1910.303(b)(2)). Portable type GFCIs must be tested each time before use. GFCIs have a built-in test circuit that imposes an imbalance between the hot and neutral on the load circuit to assure that the ground fault protection is still functioning. Test and Reset buttons are provided for testing.

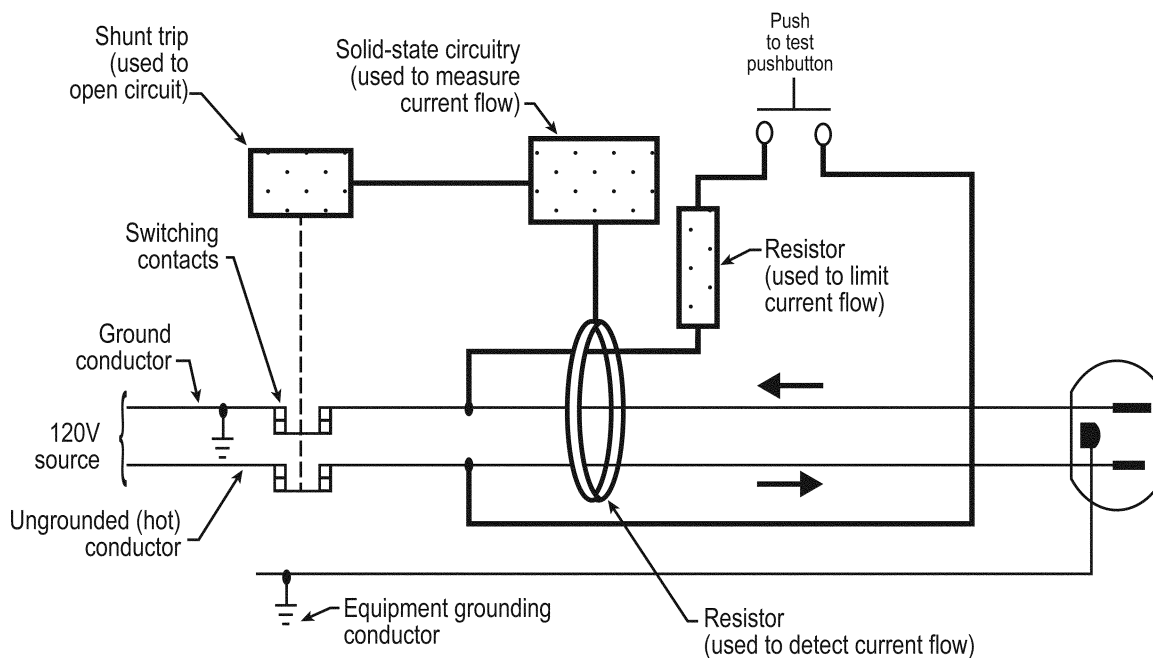

Figure C-2. Ground fault circuit interrupters

## Appendix D Polarity of Connections

### D-1. Grounding terminals

- No grounded conductor may be attached to any terminal or lead so as to reverse designated polarity.
- A grounding terminal or grounding-type device on a receptacle, cord connector, or attachment plug may not be used for purposes other than grounding.
- The above two subparagraphs dealing with polarity of connections and use of grounding terminals and devices address one potentially dangerous aspect of AC: many pieces of equipment will operate properly even though the supply wires are not connected in the order designated by design or the manufacturer. Improper connection of these conductors is most prevalent on the smaller branch circuit typically associated with standard 120V receptacle outlets, lighting fixtures, and cord- and plug-connected equipment.
- When plugs, receptacles, and connectors are used in an electrical branch circuit, correct polarity between the ungrounded (hot) conductor, the grounded (neutral) conductor, and the grounding conductor must be maintained.

### D-2. Reversed polarity

- Reversed polarity is a condition where the identified circuit conductor (the grounded conductor or neutral) is incorrectly connected to the ungrounded or "hot" terminal of a plug, receptacle, or other type of connector.
- Figure D-1 shows the correct wiring for the common 120V outlet with a portable hand tool attached.

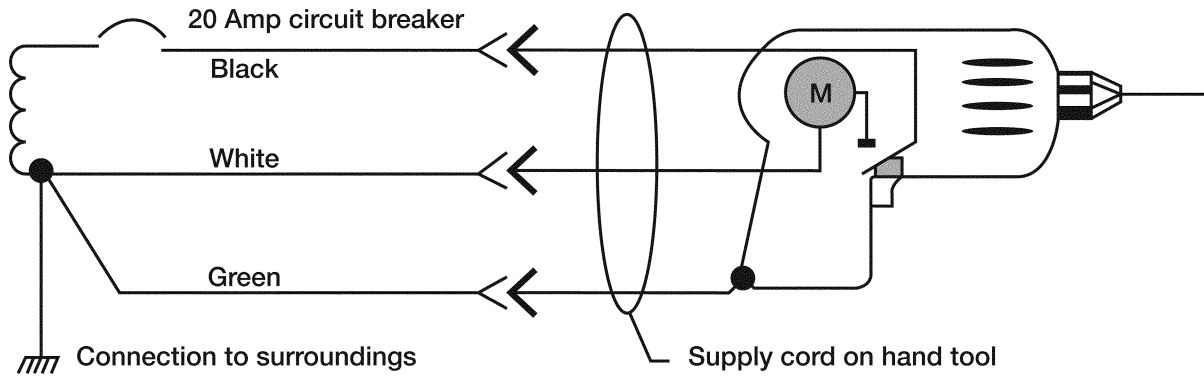

Figure D-1. Typical 120V branch circuit with correct wiring

c. Figure D-2 shows the black (ungrounded) and white (grounded) conductors reversed. This is the traditional reversed polarity. Although a shock hazard may not exist, there are other mechanical hazards that can occur.

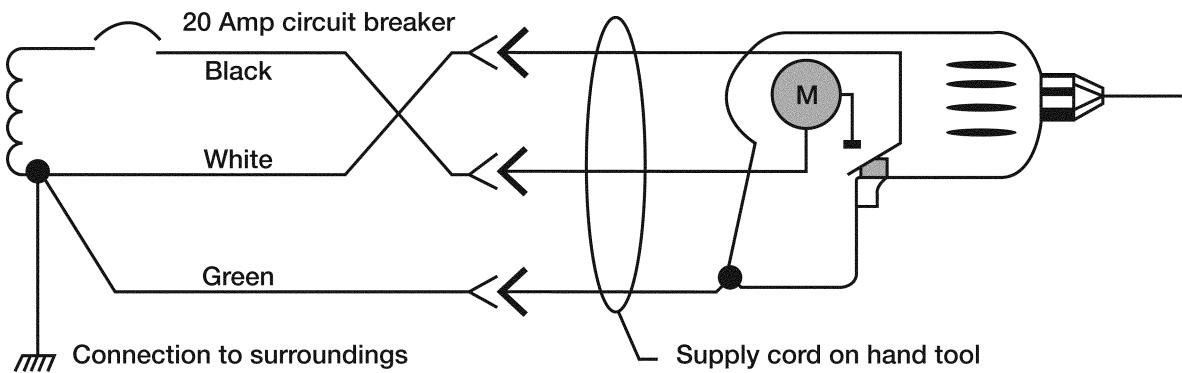

Figure D-2. 120V branch circuit with polarity reversed

d. For example, if an internal fault should occur in the wiring as shown in figure D-3, the equipment would not stop when the switch is released or would start as soon as a person plugs the supply cord into the improperly wired outlet. This could result in serious injury.

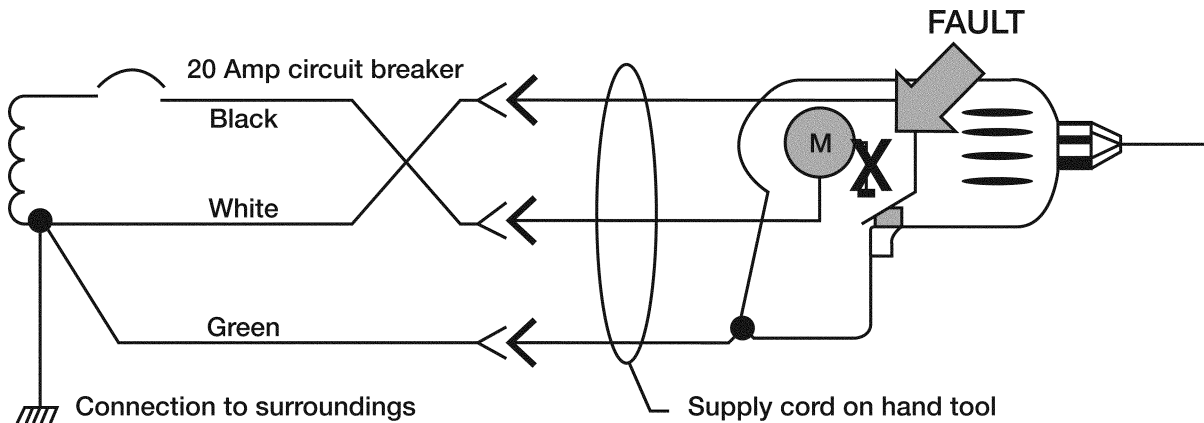
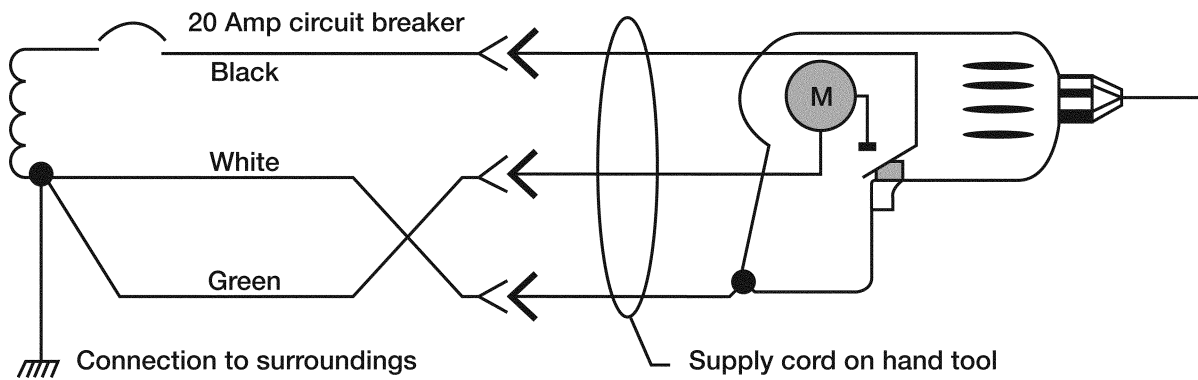

Figure D-3. Reversed polarity resulting in internal fault in equipment wiring

e. Figure D-4 shows the white (grounded) and green (grounding) conductors reversed. Although per Occupational Safety and Health Administration or code terminology this is not considered reversed polarity, a hazard can still exist. In this case, due to the wiring error, the white (grounded) wire is being used to provide equipment grounding.



f. Figure D-5 shows an extremely dangerous situation. In this example, the black (ungrounded) and green (grounding) conductors have been reversed. The metal case of the equipment is at 120V with reference to the surroundings. As soon as a person picks up the equipment and touches a conductive surface in his or her surroundings, he or she will receive a serious or even deadly shock.

g. Although the equipment will not work with this wiring error, it would not be unusual for a person to pick up the equipment before realizing this. The person may even attempt to troubleshoot the problem before unplugging the power cord.

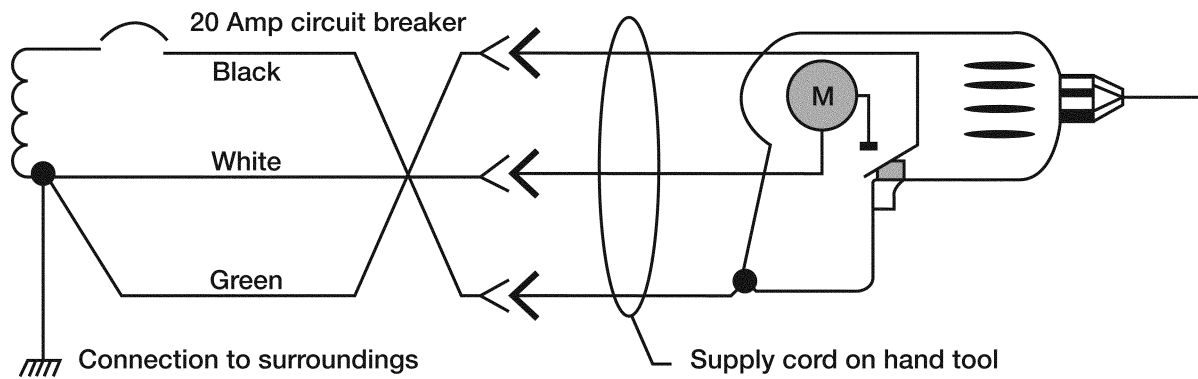

h. Correct polarity is achieved when the grounded conductor is connected to the corresponding grounded terminal and the ungrounded conductor is connected to the corresponding ungrounded terminal. The reverse of the designated polarity is prohibited. Figure D-6 illustrates a duplex receptacle correctly wired. Terminals are designated and identified to avoid confusion. An easy way to remember the correct polarity is "white to light" — the white (grounded) wire should be connected to the light or nickel-colored terminal; "black to brass" — the black or multi-colored (ungrounded) wire should be connected to the brass terminal; and "green to green" — the green or bare (grounding) wire should be connected to the green hexagonal head terminal screw.

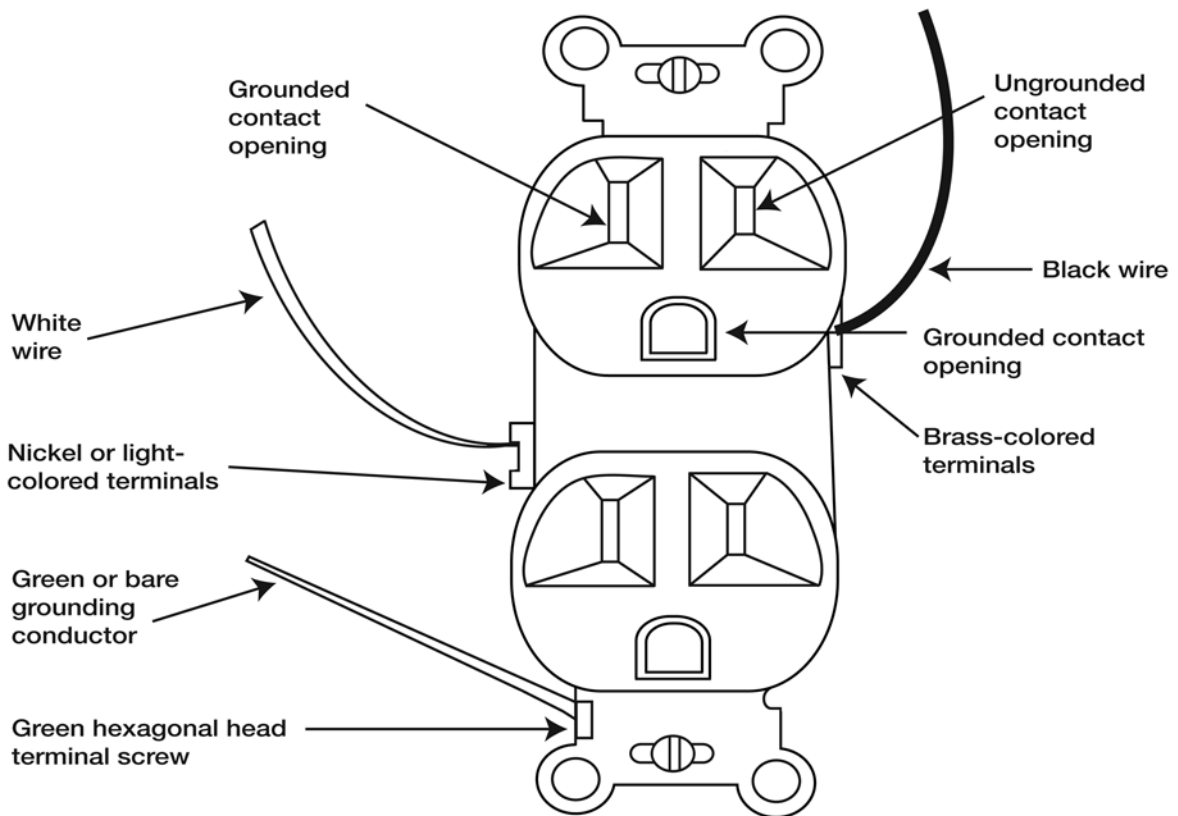

Figure D-6. Duplex receptacle correctly wired to designated terminals

i. Figure D-6 is a illustration showing the different parts of a duplex receptacle, which include the following:

- (1) Grounded contact opening.
- (2) Ungrounded contact opening.
- (3) Black wire.
- (4) White wire.
- (5) Grounding contact opening.
- (6) Brass-colored terminal.
- (7) Nickel or light-colored terminals.
- (8) Greer or bare grounding conductor.
- (9) Green hexagonal head terminal screw.

## Appendix E Grounding

### E-1. Requirements

This section contains grounding requirements for systems, circuits, and equipment. Grounding electrical circuits and electrical equipment is required to protect employees against electrical shock, safeguard against fire, and protect against damage to electrical equipment. There are two kinds of grounding:

*a.* Electrical circuit or system grounding. Electrical system grounding is accomplished when one conductor of the circuit is intentionally connected to earth. This is done to protect the circuit should lightning strike or other high voltage contact occur. Grounding a system also stabilizes the voltage in the system so "expected voltage levels" are not exceeded under normal conditions.

*b.* Electrical equipment grounding. Equipment grounding is accomplished when all metal frames of equipment and enclosures containing electrical equipment or conductors are grounded by means of a permanent and continuous

connection or bond. The equipment grounding conductor provides a path for dangerous fault current to return to the system ground at the supply source of the circuit should an insulation failure take place. If installed properly, the equipment grounding conductor is the current path that enables protective devices, such as circuit breakers and fuses, to operate when a fault occurs. Figure E-1 illustrates both types of grounding.

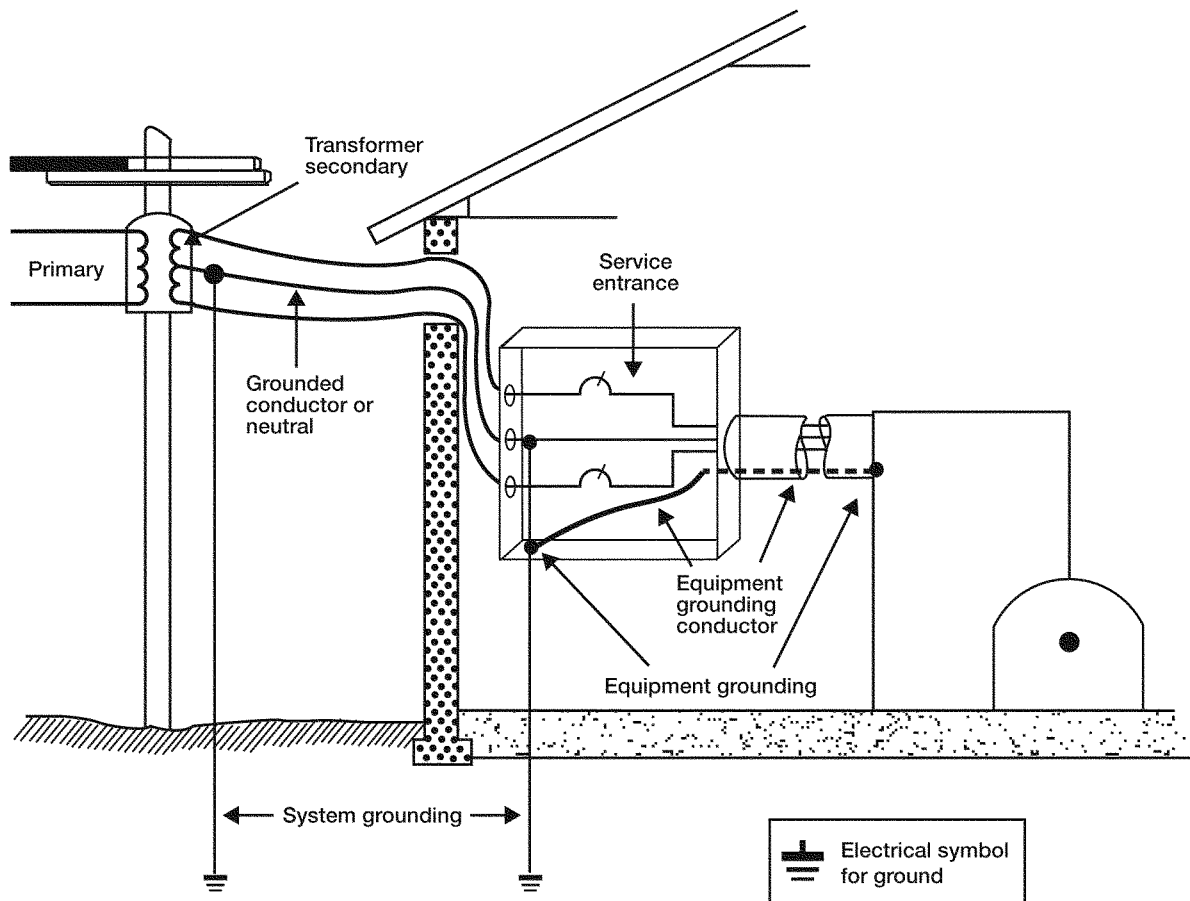

Figure E-1. System and equipment grounding

## E-2. Parts of system and equipment grounding

a. Figure E-1 is an illustration showing and describing parts of system and equipment grounding, which include the following:

- (1) Primary (transformer).
- (2) Transformer secondary.
- (3) Grounded conductor or neutral.
- (4) System grounding.
- (5) Service entrance.
- (6) Equipment grounding conductor.
- (7) Equipment grounding.

b. Most metallic raceways, cable sheaths, and cable armor which are continuous and utilize proper fittings may serve as the equipment grounding conductor. A separate grounding conductor is needed when plastic conduit, non-metallic sheathed cable, or other wiring methods are used which are not approved as grounding methods.



## Appendix F Grounding Path

The path to ground from circuits, equipment, and enclosures will be permanent and continuous.

### F–1. Effective grounding path

Effective grounding path was extracted from NFPA 70 (NEC), Article 250 (Grounding), which is more complete and fundamental to the understanding of electrical safety. It states that the path to ground—

- a. "Shall be permanent and continuous." (If the path is installed in such a way that damage, corrosion, loosening, or so forth may impair the continuity during the life of the installation, then shock and burn hazards will develop.)
- b. "Shall have capacity to conduct safely any fault current likely to be imposed on it." (Fault currents may be many times normal currents, and such high currents may melt or burn metal at points of poor conductivity. These high temperatures may be a hazard in themselves, and they may destroy the continuity of the ground fault path.)
- c. "Shall have sufficiently low impedance to limit the voltage to ground and to facilitate the operation of the circuit protective devices in the circuit." (If the ground fault path has a high impedance, there will be hazardous voltages whenever fault currents attempt to flow. Also, if the impedance is high, the fault current will be limited to some value so low that the fuse or circuit breaker will not operate promptly, if at all.)

### F–2. Safe grounding paths

It is important to remember the following regarding safe grounding paths:

- a. The fault current in AC circuits will be limited by the sum of resistance and reactance, and the only low-reactance path is that which closely follows the circuit conductors.
- b. If a metallic raceway system is used, make sure that the metallic system is continuous and permanent.
- c. In cases where a metallic raceway system is not used, provide a green or bare equipment-grounding conductor close to the supply conductors to assure that all enclosures are bonded together and to the source.

## Appendix G Standards for Electrical Protective Equipment

### G–1. Electrical protective equipment

Table G–1 shows the standards for electrical protective equipment.

**Table G–1**  
**Standards for electrical protective equipment**

Subject	Number	Title
Head protection	ANSI/ISEA Z89.1- 2009	American National Standard for Industrial Head Protection
Eye and face protection	ANSI/ISEA Z87.1- 2010	American National Standard for Occupational and Educational Personal Eye and Face Protection Devices
Gloves – rubber	ASTM D120 –09	Standard Specification for Rubber Insulating Gloves
Sleeves	ASTM D1051 - 08	Standard Specification for Rubber Insulating Sleeves
Gloves and sleeves	ASTM F496 - 08	Standard Specification for In-Service Care of Insulating Gloves and Sleeves
Leather protectors	ASTM F696 - 06 (2011)	Standard Specification for Leather Protectors for Rubber Insulating Gloves and Mittens
Footwear	ASTM F1117 - 03 (2008) ASTM F2412 - 11 ASTM F2413 - 11	Standard Specification for Dielectric Footwear Standard Test Methods for Foot Protection Standard Specification for Performance Requirements for Protective (Safety) Toe Cap Footwear
Visual inspection	ASTM F1236 - 96(2012)	Standard Guide for Visual Inspection of Electrical Protective Rubber Products
Apparel	ASTM F1506 - 10a	Standard Performance Specification for Flame Resistant and Arc Rated Textile Materials for Wearing Apparel for Use by Electrical Workers Exposed to Momentary Electric Arc and Related Thermal Hazards
Raingear	ASTM F1891 - 12	Standard Specification for Arc and Flame Resistant Rainwear

**Table G–1**  
**Standards for electrical protective equipment—Continued**

Face protective products	ASTM F2178 - 12	Standard Test Method for Determining the Arc Rating and Standard Specification for Face Protective Products
Fall protection	ASTM F887 - 12e1	Standard Specifications for Personal Climbing Equipment
Rubber protective products – visual inspection	ASTM F1236 - 96 (2012)	Standard Guide for Visual Inspection of Electrical Protective Rubber Products
Aprons	ASTM F2677- 08a	Standard Specification for Electrically Insulating Aprons

## G–2. Related protective equipment

Table G–2 shows the standards for other related protective equipment.

**Table G–2**  
**Standards for Other Related Protective Equipment**

Subject	Number	Title
Arc protective blankets	ASTM F2676 - 09	Standard Test Method for Determining the Protective Performance of an Arc Protective Blanket for Electric Arc Hazards
Blankets	ASTM D1048 - 12	Standard Specification for Rubber Insulating Blankets
Blankets – in-service care	ASTM F479 - 06 (2011)	Standard Specification for the Service Care of Insulating Blankets
Covers	ASTM D1049 - 98 (2010)	Standard Specification for Rubber Insulating Covers
Fiberglass rods – live line tools	ASTM F711 - 02 (2007)	Standard Specification for Fiberglass Reinforced Plastic (FRP) Rod and Tube Used in Live Line Tools
Insulated hand tools	ASTM F1505 - 10	Standard Specification for Insulated and Insulating Hand Tools
Ladders	ANSI ASC A14.1 - 2007	American National Standard for Ladders –Wood Safety Requirements
	ANSI ASC A14.3 - 2008	American National Standard for Ladders –Fixed-Safety Requirements
	ANSI ASC A14.4 - 2009	American National Standard Safety Requirements for Job Made Wooden Ladders
	ANSI ASC A14.5 - 2007	American National Standard for Ladders – Portable Reinforced Plastic-Safety Requirements
Line hose	ASTM D1050-05 (2011)	Standard Specification for Rubber Insulating Line Hose
Line hose and covers – in-service care	ASTM F478 - 09	Standard Specification for In Service Care of Insulating Line Hose and Covers
Plastic guard	ASTM F712 - 06 (2011)	Standard Test Methods and Specifications for Electrically Insulating Plastic Guard Equipment for Protection of Workers
Polyvinyl chloride (PVC) sheeting	ASTM F1742 – 03 (2011)	Standard Specification for PVC Insulating Sheeting
Safety signs and tags	ANSI Z535 series	Safety Color Code (series of standards for safety signs and tags)
Shield performance on live line tools	ASTM F2522 - 12	Standard Test Method for Determining the Protective Performance of a Shield Attached on Live Line Tools or on Racking Rods for Electric Arc Hazards
Temporary protective grounds in-service testing	ASTM F2249 – 03 (2009)	Standard Specification for In-Service Test Methods for Temporary Grounding Jumper Assemblies Used on De-energized Electric Power Lines and Equipment
Temporary protective grounds – test specification	ASTM F855 - 09	Standard Specifications for Temporary Protective Grounds to Be Used on De-energized Electric Power Lines and Equipment

## Appendix H

### Hazard Analysis Factors Prior to Performing Electrical Work

#### H–1. General

The following list is not all inclusive, but provides suggestions for factors to consider. Remember that one goal of the pre-job brief is to assure that all workers understand the hazards and controls.

## H-2. Factors

- a. Describe the modes of electrical work that will be conducted during this work activity (for example, de-energized work, verification of zero energy, energized work, tuning and adjusting).
- b. What electrical hazards will the worker encounter, or be exposed to during each step of the work? Examples include shock, thermal burn, and arc flash.
- c. What are the shock and arc flash boundaries?
- d. How close will any portion of the worker(s) body come to exposed electrical conductors? Which of the boundaries, if any, will the worker cross?
- e. At what steps or phases of this activity is the worker(s) exposed to electrical hazards?
- f. What can go wrong, or what mistake could be made, that would expose the worker to an electrical hazard?
- g. Is a second person or safety watch required for any steps of this activity?
- h. If so, what are their specific duties and training and/or knowledge requirements?
- i. What electrical PPE is required? Does it require certification? If so, is it current?
- j. Do the workers have training to inspect and use the electrical PPE?
- k. Are there nonelectrical hazards that have controls that could conflict with the electrical hazard controls? Specific examples include uniforms that contain nylon, clean room coats, or respirators that are not arc flash rated, and chemical or glove box gloves that are not voltage rated. If so, how will this be resolved?
- l. Is an SOP or EEWP required for this work?
- m. Is there a point in the work where the electrical hazard(s) have been mitigated and the electrical PPE can be removed?
- n. Are there multiple groups, contractors, or crafts involved? How is this managed to assure communication and understanding among all groups?
- o. Does this work require the removal of jewelry, badges, or other dangling objects?
- p. Can the electrical energy result in a noise hazard?
- q. What could go wrong that would require a pause or stop work?
- r. What workers are cardiopulmonary resuscitation and/or automated external defibrillation trained? Where is the nearest automated external defibrillation equipment?
- s. How would an electrical shock or arc flash injury be handled?
- t. Where is the nearest phone? How long would it take for emergency response to arrive?
- u. Are any special tools or test equipment to be used? Are they adequately voltage rated, if necessary?
- v. How will any electrical energy stored in capacitors be removed?
- w. Are there other workers in the vicinity that could be endangered by any exposed electrical hazards, such as arc flash, noise, electromagnetic fields, and so forth?
- x. How will access to the electrical work be controlled?

## Appendix I

### Guidelines for Equipment Inspection and Approval by the Authority Having Jurisdiction

#### I-1. General

In-house built, other manufacturer, and/or modified NRTL-listed electrical equipment must be examined. Check the items listed below as applicable.

#### I-2. External inspection

- a. *Enclosure.*
  - (1) Operator not exposed to any hazard.
  - (2) Not damaged.
  - (3) Appropriate material.
  - (4) Protects contents from operating environment.
  - (5) Adequate to protect against shock.
  - (6) Contains any arcs, sparks, and electrical explosions.
- b. *Power source.*
  - (1) Cords and plugs.
    - (a) Proper voltage and ampacity rating for cord and plug.
    - (b) Grounding conductor included, if required.
    - (c) Not frayed or damaged.
    - (d) Proper wiring of plug.

- (e) Strain relief on cord.
- (2) Direct-wired into facility.
- (a) Proper voltage and ampacity rating for wiring method.
- (b) Installed in accordance with NFPA 70 (NEC).
- (c) Proper loading and overcurrent protection in branch circuit.
- c. *Grounding.*
  - (1) Ground from cord or other is terminated properly.
  - (2) All noncurrent-carrying exposed metal is bonded properly.
  - (3) All noncurrent-carrying internal subsystems are bonded properly.
  - (4) Equipment ground is run with circuit conductors.
  - (5) Auxiliary ground permitted.
  - (6) Termination checked.
- d. *Foreign power supplies and equipment.*
  - (1) Connected to facility power with appropriate adapters.
  - (2) Correct voltage, frequency, and phasing.
  - (3) Correct wire ampacity for use in United States.
- e. *Overcurrent protection.* Overcurrent protection located in equipment or branch circuit.
- f. *Marking requirements.*
  - (1) Hazards, including stored energy.
  - (2) Power requirements (voltage, current, frequency, power).
  - (3) Make, model, and/or drawing number.
  - (4) Restrictions and limitations of use.
- g. *Other requirements.*
  - (1) Adequate documentation.
  - (2) Procedures to use (for example, installation wiring diagram).
  - (3) Training and qualifications.
- h. *Secondary hazards.*
  - (1) Radio frequency.
  - (2) Dielectric or magnetic fields.
  - (3) Infrared, visible or ultraviolet.
  - (4) X-rays.
  - (5) Fire, electrical explosion.

### **I-3. Internal inspection**

- a. *Internal wiring.*
  - (1) Polarity.
  - (2) Phasing.
  - (3) Landing of ground.
  - (4) Line voltage and high voltage separate from low voltage.
  - (5) Wiring terminals and leads.
  - (6) Wire size.
  - (7) Proper dielectric.
  - (8) Clearance/creepage distances for high voltage.
  - (9) Listed conductors, if applicable.
- b. *Other internal issues.*
  - (1) Neat workmanship.
  - (2) Listed components used, if applicable.
  - (3) Proper management of conductors.
  - (4) Free of sharp edges.
  - (5) Proper cooling.
  - (6) Automatic discharge of high-voltage capacitor.
- c. *Tests performed.*
  - (1) Ground continuity (less than 1 ohm).
  - (2) Polarization of cord and plug.
  - (3) Auto discharge of high-voltage capacitor.
  - (4) Functional tests (for example, GFCI and emergency shut-off).

*d. Failure analysis.*

- (1) Effect of ground fault.
- (2) Effect of short circuit.
- (3) Effect of interlock failure.
- (4) Effect of overload.
- (5) Effect of incorrect setting.

*e. Maintenance.* Any safety issues with access and maintenance.

## **Glossary**

### **Section I Abbreviations**

**AC**

alternating current

**AHJ**

authority having jurisdiction

**ANSI**

American National Standards Institute

**AR**

Army regulation

**ASTM**

American Society for Testing and Materials International

**BS**

British Standard

**CE**

European Conformity

**CFR**

Code of Federal Regulations

**cal/cm<sup>2</sup>**

calories/square centimeters

**cm**

centimeter

**DA**

Department of the Army

**DC**

direct current

**EEWP**

Energized Electrical Work Permit

**EU**

European Union

**ft**

foot (feet)

**FPE**

force provider expeditionary

**FR**

fire-resistant

**FRP (publication)**

fiberglass-reinforced plastic

**GFCI**

ground fault circuit interrupter

**Hz**  
hertz

**in**  
inch

**ISEA**  
International Safety Equipment Association

**kV**  
kilovolt

**m**  
meter(s)

**mA**  
milliamperes

**mm**  
millimeter

**NEC**  
National Electrical Code

**NFPA**  
National Fire Protection Association

**NRTL**  
Nationally Recognized Testing Laboratory

**O&M (publication)**  
operation and maintenance

**Pam (publication)**  
pamphlet

**PPE**  
personal protective equipment

**PVC**  
polyvinyl chloride

**SOP**  
standard operating procedure

**TSEWG**  
Tri-Service Electrical Working Group

**U.S.**  
United States

**UFC**  
Unified Facilities Criteria

**USC**  
United States Code

**V**  
volt

## **Section II**

### **Terms**

#### **Ampacity**

The current, in amperes, that a conductor can carry continuously under the conditions of use without exceeding its temperature rating.

#### **Appliance**

Utilization equipment, generally other than industrial, that is normally built in standardized sizes or types and is installed or connected as a unit to perform one or more functions such as clothes washing, air conditioning, food mixing, deep frying, and so forth.

#### **Arc flash hazard**

A dangerous condition associated with the possible release of energy caused by an electric arc.

#### **Arc flash hazard analysis**

A study investigating a worker's potential exposure to arc flash energy, conducted for the purpose of injury prevention and the determination of safe work practices, arc flash protection boundary, and the appropriate levels of PPE.

#### **Arc flash suit**

A complete fire-rated clothing and equipment system that covers the entire body, except for the hands and feet. This includes pants, jacket, and beekeeper-type hood fitted with a face shield.

#### **Attachment plugs**

A device that, by insertion in a receptacle, establishes a connection between the conductors of the attached flexible cord and the conductors connected permanently to the receptacle.

#### **Authority having jurisdiction**

The organization, office, or individual responsible for approving equipment, materials, an installation, or a procedure.

#### **Barricade**

A physical obstruction such as tapes, cones, or A-frame-type wood or metal structures intended to provide a warning about and to limit access to a hazardous area.

#### **Barrier**

A physical obstruction that is intended to prevent contact with equipment or energized electrical conductors and circuit parts or to prevent unauthorized access to a work area.

#### **Branch circuits**

The circuit conductors between the final overcurrent device protecting the circuit and the outlet(s).

#### **Boundary, arc flash protection**

When an arc flash hazard exists, an approach limit at a distance from a prospective arc source within which a person could receive a second degree burn if an electrical arc flash were to occur.

#### **Boundary, limited approach**

An approach limit at a distance from an exposed, energized electrical conductor or circuit part within which a shock hazard exists.

#### **Boundary, prohibited approach**

An approach limit at a distance from an exposed, energized electrical conductor or circuit part within which work is considered the same as making contact with the electrical conductor or circuit part.

#### **Boundary, restricted approach**

An approach limit at a distance from an exposed, energized electrical conductor or circuit part within which there is an increased risk of shock, due to electrical arc over combined with inadvertent movement, for personnel working in close proximity to the energized electrical conductor or circuit part.



**Circuit breaker**

A device designed to open and close a circuit by nonautomatic means and to open the circuit automatically on a predetermined overcurrent without damage to itself when properly applied within its rating.

**Conductor-A**

Material (usually a wire, cable, or bus bar) for carrying an electric current.

**De-energized**

Free from any electrical connection to a source of potential difference and from electrical charge; not having a potential different from that of the earth.

**Device**

A unit of an electrical system that carries or controls electric energy as its principal function.

**Electrical hazard**

A dangerous condition such that contact or equipment failure can result in electric shock, arc flash burn, thermal burn, or blast.

**Electrical safety**

Recognizing hazards associated with the use of electrical energy and taking precautions so that hazards do not cause injury or death.

**Electrical safe work condition**

A state in which an electrical conduct or circuit part has been disconnected from energized parts, locked and/or tagged in accordance with established standards, tested to ensure the absence of voltage, and grounded, if determined necessary.

**Energized**

Electrically connected to or having a source of voltage.

**Exposed (as applied to live parts)**

Circuit is in such a position that, in case of failure of supports or insulation, contact with another circuit may result. Capable of being inadvertently touched or approached nearer than a safe distance by a person. It is applied to parts that are not suitably guarded, isolated, or insulated.

**Fuses**

An overcurrent protective device with a circuit-opening fusible part that is heated and severed by the passage of overcurrent through it.

**Grounded**

Connected to ground or to a conductive body that extends the ground connection.

**Ground conductor**

A system or circuit conductor that is intentionally grounded.

**Ground fault**

An unintentional, electrically conducting connection between an ungrounded conductor of an electrical circuit and the normally noncurrent-carrying conductors, metallic enclosures, metallic raceways, metallic equipment, or earth.

**Ground fault circuit interrupter**

A device intended for the protection of personnel that functions to de-energize a circuit or portion thereof within an established period of time when a current to ground exceeds the values established for a Class A device.

**Insulated**

Separated from other conducting surfaces by a dielectric (including air space) offering a high resistance to the passage of current.

**Live parts**

Energized conductive components.

**Outlet**

A point on the wiring system at which current is taken to supply utilization equipment.

**Overcurrent**

Any current in excess of the rated current of equipment or the ampacity of a conductor. It may result from overload, short circuit, or ground fault.

**Panelboard**

A single panel or group of panel units designed for assembly in the form of a single panel, including buses and automatic overcurrent devices, and equipped with or without switches for the control of light, heat, or power circuits; designed to be placed in a cabinet or cutout box placed in or against a wall, partition, or other support; and accessible only from the front.

**Qualified person**

One who has skills and knowledge related to the construction and operation of electrical equipment and installations and has received safety training to recognize and avoid the hazards involved.

**Receptacle**

A contact device installed at the outlet for the connection of an attachment plug. A single receptacle is a single contact device with no other contact device on the same yoke. A multiple receptacle is two or more contact devices on the same yoke.

**Service**

The conductors and equipment for delivering electric energy from the serving utility to the wiring system of the premises served.

**Service conductors**

The conductors from the service point to the service disconnecting means.

**Service drop**

The overhead service conductors from the last pole or other aerial support to, and including, the splices, if any, connecting to the service entrance conductors at the building or other structure.

**Shock hazard**

A dangerous condition associated with the possible release of energy caused by contact or approach to energized electrical conductors or circuit parts.

**Switchboard**

A large single panel, frame, or assembly of panels on which are mounted, on the face, back, or both, switches, overcurrent and other protective devices, buses, and, usually, instruments. Switchboards are generally accessible from the rear as well as from the front and are not intended to be installed in cabinets.

**Switching device**

A device designed to close, open, or both, one or more electric circuit(s).

**Unqualified person**

A person who is not a qualified person.

**Voltage (of a circuit)**

The greatest root-mean-exposure (effective) difference of potential between any two conductors of the circuit concerned.

**Voltage, nominal**

A nominal value assigned to a circuit or system for the purpose of conveniently designating its voltage class (for

example, 120/240V, 480Y/277V, or 600V). The actual voltage at which a circuit operates can vary from the nominal within a range that permits satisfactory operation of equipment.

**Voltage to ground**

For grounded circuits, the voltage between the given conductor and that point or conductor of the circuit that is grounded; for ungrounded circuits, the greatest voltage between the given conductor and any other conductor of the circuit.

**Section III**

**Special Abbreviations and Terms**

This section contains no entries.

**UNCLASSIFIED**

**PIN 103331-000**